



Engine Liquid Filtration Guide

Fuel, Lube and Coolant Filtration Solutions for Heavy-duty Engines, Vehicles and Equipment



Filtration Solutions for Today's Diesel Engines

Diesel engine technology continues to evolve quickly in response to increasingly stringent emissions standards. Donaldson understands the filtration challenges faced by modern engines and offers a broad array of solutions to meet even the most demanding requirements.

Whatever your filtration challenge – Donaldson delivers.



Routine Maintenance. At the right time.

PREDICTIVE FILTRATION MONITORING SOLUTION

Efficient and effective filtration solutions have long been a vital part of any fleet management plan. But what if your filters could talk to you in real time? And what if you could easily monitor oil condition, too? The cloud-based technology of Donaldson Filter Minder™ Connect communicates the status of vital filters and oil in your fleet in real time, so you can get the most out of all your equipment through optimized maintenance intervals.



Wireless monitoring technology sends filter and oil condition data to the cloud.



Informed maintenance decisions.



Real-time data enables you to more effectively anticipate and plan filtration maintenance.



Low cost of ownership.



Maintenance practices can be optimized across the entire fleet.



Supports productivity and uptime.

Please contact your Donaldson representative for availability within your region.



Overview

- Why Choose Donaldson 2
- Product Overview 3
- Comprehensive Capabilities 4

Fuel Filtration

- Custom Fuel Solutions 8
- Donaldson Blue® Fuel Filters 10
- Diesel Engine Fuel Filtration Overview 11
- Fuel Filter Media 12
- 76 mm / 3.0" Diameter Filter Assembly 15
- 93 mm / 3.66" Diameter Filter Assembly 18
- 108 mm / 4.25" Diameter Filter Assembly 22
- 118 mm / 4.65" Diameter Filter Assembly 26

Lube Filtration

- Donaldson Blue® Lube Filters 30
- Diesel Engine Lube Filtration Overview 31
- Lube Filter Media 32
- Extended Oil Drain Intervals 33
- 93 mm / 3.66" Diameter Filter Assembly 35
- 118 mm / 4.65" Diameter Filter Assembly 37
- 118 mm / 4.65" Diameter Filter Assembly 39

Coolant Filtration

- Donaldson Blue® Coolant Filters 42
- Diesel Engine Coolant Filtration Overview 43
- Coolant Filter Media 43
- 93 mm / 3.66" Diameter Filter Assembly 44

Technical Reference

- Custom System Design Application Worksheets**
- Fuel Systems 56
- Lube Systems 58

NOTE Please contact your Donaldson representative for availability of parts within your region. Some parts listed within this catalog may require lead times.



shop.donaldson.com

At Donaldson, we've worked hard to make finding filters and parts simple with easy-to-use online tools and a knowledgeable support staff. The filters and parts you need are always just a click away.





Filtration is our Focus

Our focus on filtration began in 1915, when Frank Donaldson created the first air filter for a heavy duty engine. The business has grown steadily, highlighted by the introduction of our first liquid filters over 50 years ago. Today we offer a full portfolio of fuel, lube and coolant solutions for a wide range of on- and off-road engines and equipment.

For fleet/equipment owners or original equipment manufacturers, we know what questions to ask, we have ready-made solutions to address the liquid filtration challenges of most standard engines, and we have the experienced engineers to design and efficiently build customized solutions for new engine and equipment platforms. Whatever your filtration challenge – Donaldson delivers.

Focus on Filtration

A century of dedication to filtration – delivering innovations that work for you.

Innovation: We are the inventors of future-shaping technologies such as PowerCore®, Ultra-Web®, and Synteq XP™ – with over 2,400 active patents. Our customized solutions are driven by innovative analysis and are designed to integrate filtration systems into your platforms. We also offer preferred-fit product design options, such as SELECT™ fuel, to ensure genuine parts retention – while protecting your revenue and your reputation.

First-Fit Choice: We're the first-fit choice of equipment manufacturers around the world – and we put the same technology and care into every Donaldson branded product.

Comprehensive Support

Support begins and ends with our people – who are committed to your growth.

People-Centric Service: Our knowledgeable and extremely helpful sales, engineering and customer support teams are available to help whenever – and wherever in the world – you need us. They have in-depth knowledge of the filtration needs in the markets you serve – and are adept at leveraging that knowledge across your business.

Operational Alignment

Award winning execution tailored to your unique business goals.

Reach and Scalability: We have nearly 50 global manufacturing locations in 25 countries; making it possible for us to deliver the products you need, where you need them. Our design, development, ordering, logistics and data management tools create efficiency throughout our business interactions.

Measurable Quality – Real Value

Our dedication to quality strengthens your brand and protects your reputation.

Hardworking Filters: We measure and perform to the most stringent quality standards in the industry and stand behind the products we manufacture.

Filtration Solutions for Today's Diesel Engines

Diesel engine technology continues to evolve quickly in response to increasingly stringent emissions standards. Today's engines now operate at much higher temperatures and under much greater pressures. Because tolerances have become tighter, contamination control for fuel, lube, and coolant systems is critical. Donaldson understands the filtration challenges faced by modern engines and offers a broad array of solutions to meet even the most demanding requirements.

Fuel Filtration *see page 7*

Systems to Address Today's Fuel Challenges

High-pressure fuel injection systems require more efficient fuel filtration with longer life. Donaldson fuel filter assemblies provide you with the flexibility to select the proper filtration system to meet your fuel quality requirements.



Fuel Assembly Options

Families by Filter Diameter	Maximum Flow Range	
	Primary	Secondary
76 mm / 3.00 in	up to 95 lph / 25 gph	up to 150 lph / 40 gph
93 mm / 3.66 in	up to 400 lph / 100 gph	up to 450 lph / 120 gph
108 mm / 4.25 in	up to 600 lph / 160 gph	up to 600 lph / 160 gph
118 mm / 4.65 in	up to 840 lph / 220 gph	up to 1080 lph / 285 gph

Lube Filtration *see page 29*

Design Flexibility for a Wide Range of Applications

Donaldson lube oil filter assemblies are engineered with a range of medias to provide the best performance, efficiency and dirt holding capacity with low pressure drop. We offer both both by-pass and full-flow filtration designs.



Lube Assembly Options

Families by Filter Diameter	Filter Design	Maximum Flow Range
93 mm / 3.66 in	Full-Flow	91 lpm / 24 gpm
118 mm / 4.65 in	Full-Flow	170 lpm / 45 gpm
	By-Pass (Secondary)	6.62 lpm / 1.75 gpm at 85 psi

Coolant Filtration *see page 41*

Remote Mount Assemblies for Ease of Service

Chemical balance is the key to selecting the right filter for your cooling system. Donaldson allows you to choose the filter assembly that suits your servicing schedules, while maintaining the operating conditions for optimal fuel economy.



Coolant Assembly Option

Filter Diameter	Maximum Flow Range
93 mm / 3.66 in	1500 lpm / 400 gpm



Comprehensive Capabilities

For over a century, Donaldson has been a pioneer in filtration technology, manufacturing and testing. In the tightly regulated markets, our research and development efforts have produced more efficient filters and filtration systems. Donaldson has in-house engineering expertise and is constantly investing in research and development to improve system designs and filtration technologies.

Our technologies help protect critical applications from the damaging effects of particles and water in bio-fuel and other engine liquids. As equipment and technology advances, Donaldson continues to develop innovative solutions to anticipate and exceed evolving engine and fuel injector requirements.

Filter Media Design and Development

From traditional cellulose to synthetic, the development of proprietary filtration substrates is at the heart of every Donaldson filtration system. If our existing media formulation doesn't meet our customer's specifications, our scientists use our in-house media development laboratory to design new formulations to meet those needs.

Donaldson has many internally developed proprietary computer models which enable us to predict media performance for a given fiber mixture, initial pressure loss for filter elements of various configurations, and filter loading with many different contaminants. This enables us to quickly work through many design concepts to optimize the filtration system for a unique application.

Media Characterization Testing

- Permeability
- Tensile strength
- Mullen burst
- Basis weight
- Pore size
- Thickness
- Gurley stiffness
- LEFS bench
- 3-Point bend

In-House Media Mill

- For application development
- Trial media production runs
- Development of proprietary formulations

Filtration Performance Testing

- Particle counting
- Multi-pass testing

Filtration Development, Testing and Analysis

Donaldson has pioneered the use of a wide range of engineering, design and testing tools used during the product development and validation process. Donaldson is fully committed to delivering quality products and being a responsible corporate citizen. You'll find that Donaldson strives to meet or exceed customer requirements and we do so by coordinating continuous improvement activities.

Engineering Capabilities

- Global design centers
- Prediction and simulation

Development and Validation

- Filtration performance testing per SAE and ISO standards

Test and Evaluation Tools

- Structural analysis per SAE, ISO, and NFPA standards
- Filtration performance testing
- Analytical chemistry laboratory

Design Validation

- Global test cell locations
- Pressure drop, high-temp, flow fatigue, used oil analysis, component durability, and fluid compatibility
- Vibration
- Field testing
- Field data acquisition



Quality and Environmental Management

The work we do every day—creating filtration products and processes that help our world run cleaner and more efficiently—is more important than ever. Donaldson is fully committed to delivering quality products and being a responsible corporate citizen. You'll find that Donaldson strives to meet or exceed customer requirements and we do so by coordinating continuous improvement activities.

All facilities are ISO/AS certified.

Global Presence with a Local Touch

As a global filtration supplier, Donaldson has built a strong, flexible and responsive distribution network to serve our customers around the world. Regardless of region, you can count on Donaldson for consistent manufacturing processes, safety, environmental and quality expectation.

Localized Manufacturing – It starts with 45+ manufacturing locations around the world – producing most filters in the regions where they're used.

Primary Distribution Centers – Filters then move to our regional warehouses and distribution center hubs – meaning the filters you need are never far away.

Logistics – We work with a network of transportation and logistics companies, consolidators and cross-docking facilities to deliver products to distribution partners quickly and efficiently.

Distribution Partners – We've built one of the largest, strongest and most responsive distributor networks in the filter industry – meaning you can find the filters and support you need, nearly anywhere in the world.

Easy.



Easier.

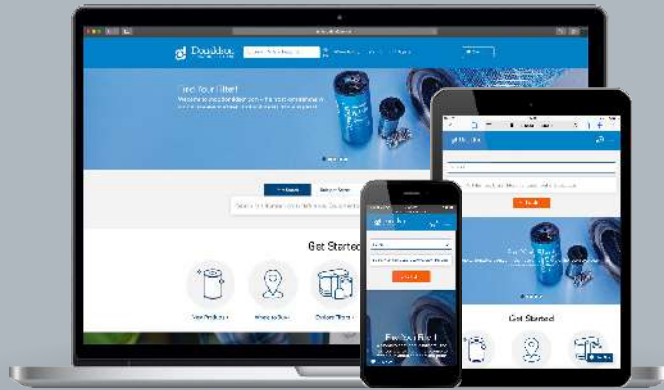

NOW YOU CAN SHOP FOR DONALDSON REPLACEMENT FILTERS ONLINE.

Visit shop.donaldson.com on your computer, phone or tablet to find all your top-quality aftermarket filters including fuel, lube, coolant and air intake filters for diesel engines, hydraulic and bulk tank filtration—plus exhaust system components. Distributors can now order directly with a secure login that provides access to all your account information—including past orders—so you can simply re-order with a click.

Shop.donaldson.com makes ordering replacement filters easier than easy so you can keep your business moving.

Shop for filters the easier way at
shop.donaldson.com



Filter Assemblies

Systems to Address Today's Fuel Challenges

Overview

Custom Fuel Solutions.....	8
Donaldson Blue® Filters.....	10
Diesel Engine Fuel Filtration Overview.....	11
Filter Media.....	12

Fuel Filtration Systems



76 mm / 3.0" Filter Diameter.....15

Primary Flow Range up to 150 lph / 40 gph
Secondary Flow Range up to 150 lph / 40 gph



93 mm / 3.66" Filter Diameter.....18

Primary Flow Range up to 400 lph / 100 gph
Secondary Flow Range up to 450 lph / 120 gph



108 mm / 4.25" Filter Diameter.....22

Primary Flow Range up to 600 lph / 160 gph
Secondary Flow Range up to 600 lph / 160 gph



118 mm / 4.65" Filter Diameter.....26

Primary Flow Range up to 840 lph / 220 gph
Secondary Flow Range up to 1080 lph / 285 gph



SELECT™ OEM Filtration Technology

Protect your Investment with Donaldson's Most Advanced Filtration Technology

Donaldson SELECT filtration technology provides the latest fuel filtration advancements and industry-leading protection for Original Equipment Manufacturers. The modular SELECT product line offers highly configurable components that can be packaged with our advanced Synteq XP™ Media Technology – or with other Donaldson media offerings – to address today's most complex fuel challenges.

Better Fuel Filtration is Key for Modern Fuel Systems

Today's diesel engines need to maintain high performance levels to remain compliant with stringent Tier 4 Final and Euro 5/6 emissions regulations. Fuel filtration plays a key role, with modern high pressure common rail (HPCR) fuel injectors operating at pressures up to 30,000 - 45,000 psi (2,000 - 3,100 bar). This means it's important to deliver clean and dry fuel to today's highly engineered fuel system pumps and injectors to maintain performance.

Modern HPCR fuel systems require extremely clean fuel delivered under the most severe operating conditions. Advanced media technologies are required to protect highly pressurized and sensitive fuel systems from water and contaminants, particularly under dynamic, real-world operating conditions.

As your filtration partner, Donaldson has the expertise and technical capabilities to navigate the challenges of today's fuels and fuel systems. Our modular SELECT product line gives you access to our most advanced filtration technology designed for specific equipment and applications, with your customers' geographic location in mind.



Synteq XP™ Media Technology

Donaldson proprietary Synteq XP filter media for Tier 4 engines takes fuel filtration performance to a whole new level by providing enhanced engine and system component protection.

Primary Filtration

Multi-Stage Coalescing Synteq XP Media

Water in fuel is a complex challenge for modern HPCR fuel systems. Water damage can result in corrosion, rust and pitting.

Donaldson Synteq XP coalescing technology offers:

- Remove more water – both coarse and emulsified
- Perform consistently over the life of the filter

Secondary Filtration

High-Efficiency Synteq XP Media

Synteq XP offers industry-leading contaminant removal and retention for secondary filtration – all under the dynamic operating conditions that your engines and equipment experience every day.

Donaldson Synteq XP technology offers:

- Higher efficiency for optimal engine protection, or
- Extended filter life
- Versatile and smaller filter configuration options

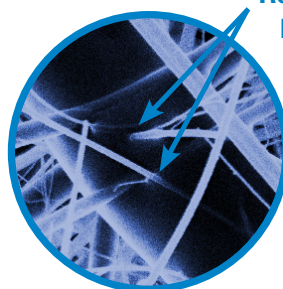

Resin-free, thermally bonded fibers

Synteq XP media creates small, consistent inter-fiber spacing – increasing filter capacity. These unobstructed pores result in reduced pressure drop and increased surface area for capturing and retaining smaller particles.

SELECT™ OEM Filter Assembly Package Options

			
	80mm	93mm	108mm
Maximum Flow Rate			
Primary Filtration	up to 225 lph / 60 gph	up to 380 lph / 100 gph	up to 450 lph / 120 gph
Secondary Filtration	up to 380 lph / 100 gph	— to be determined —	— to be determined —
Head Options			
	Basic Aluminum Basic Plastic Hand Priming Pump E-Pump	Basic Aluminum Hand Priming Pump	Basic Aluminum Hand Priming Pump E-Pump
Pump Options			
Hand Priming Pump	Bellows Style	Piston Style	Piston Style
E-Pump	12 or 24V Brushless	None	12 or 24V Brushless
Porting Size Options			
	9/16 - 18 SAE M14 x 1.5 M16 x 1.5	9/16 - 18 SAE M14 x 1.5 M16 x 1.5	M16 x 1.5 M18 x 1.5 M22 x 1.5
Heater Options			
	Not Applicable	Heater Options Available	
Media Options			
	Custom Performance Packaging <i>Advanced Synteq XP, Synteq or Standard Cellulose media</i>		
Water Management			
Clear Water Bowl	80ml	200ml	220ml
Water-in-Fuel (WIF) Sensor	Digital or Passive with multiple connector types		
Technology Package	Barrier	Multi-Stage Coalescing + Barrier	Multi-Stage Coalescing + Barrier
		Barrier	Barrier

NOTE

This product is configured with the specifications, performance and features of your choice. Lead times will apply.

Contact your Donaldson sales representative for more details.



4x Cleaner Fuel

THAN THE BEST COMPETITIVE FILTER



Clean fuel minimizes expensive repairs and unplanned downtime – it's better for high pressure common rail (HPCR) fuel systems, including injectors, pumps, and engines.

Donaldson.
BLUE



Diesel Engine Fuel Filtration Systems

Diesel fuel and diesel fuel systems are ever-changing technologies. Over the past decade, numerous emission standards and engineering achievements provided some of the most advanced, clean, and flexible engine designs, yet the advancements have also included the acceptance of alternative forms of fuels such as biodiesel.

Fuel filter performance and technology have also been challenged by these rapid changes. Today secondary filtration demands 4-5 μm absolute efficiency at 99.9%, while matching with an upstream primary filter of 7-25 μm at 99% efficiency (per ISO 19438). These changes come with the expectation that water separation, filter efficiency and life remain constant or are improved upon. Donaldson engineers have proven to be up to this challenge through the advancement of media technologies.

Fuel filtration today is an integral part of the complete fuel system. A well designed fuel system takes contamination control into account from the beginning. Water separation, particulate and non-traditional contaminants need to be controlled. Engineers must be conscious of the relationship between the fuel circuit design and overall system cleanliness.

Global fuel quality concerns are critical and end user needs need to be understood. Documentation such as the World Wide Fuel Charter exists to promote convergence of various regional practices. Fuel system design type, preferred alternate fuels and maintenance practices must be taken into account during the design process. Providing lasting, high quality fuel filtration solutions to our customers is our goal at Donaldson.

TYPICAL DIESEL ENGINE FUEL CIRCUIT

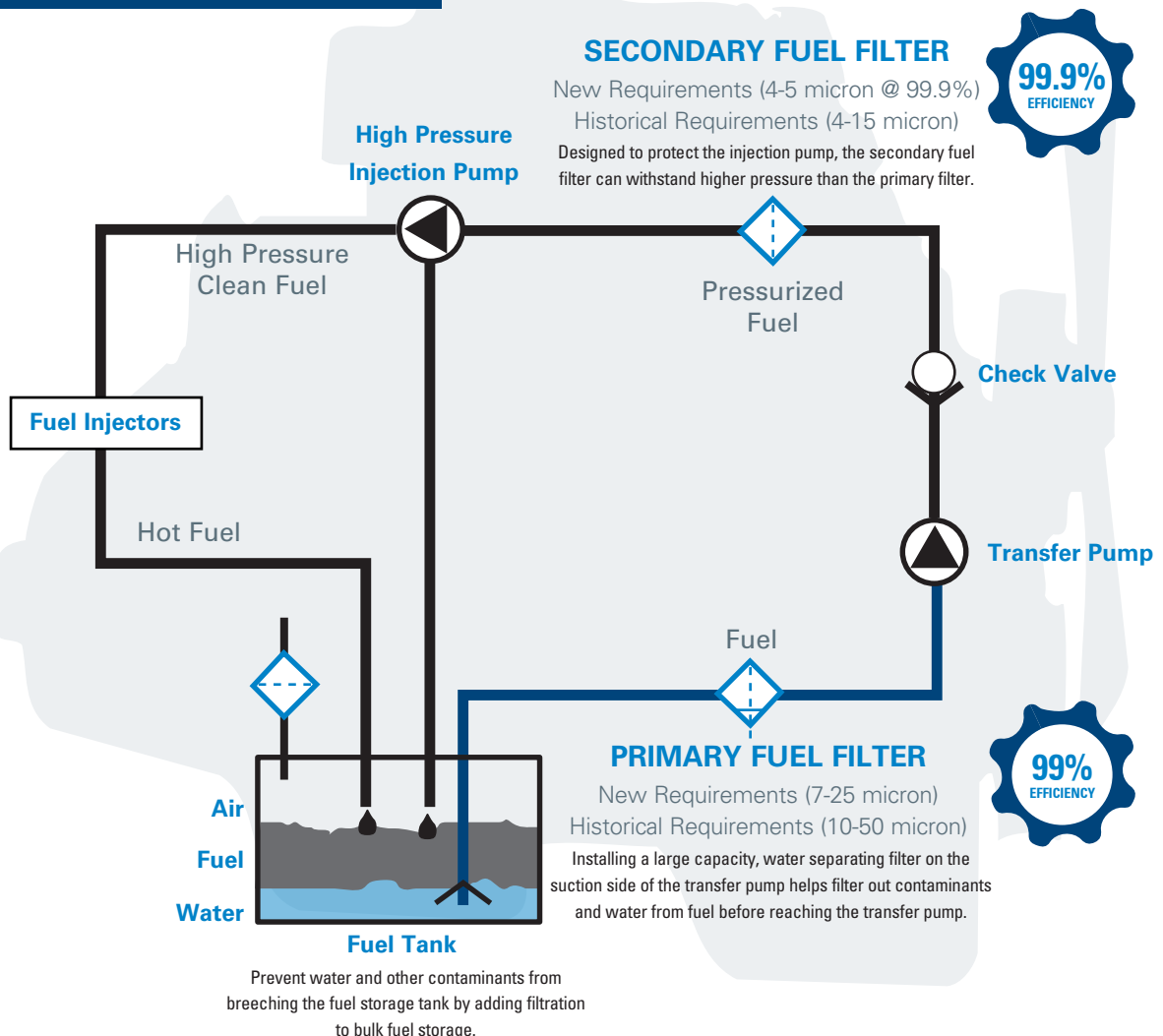



Filter Media

Filtration media represents the foundation of any filter design. Mastering the science of media creation is a key focus at Donaldson. The media representations below highlight some of the more commonly used media types in this evolving industry.

Today's engines are built with more stringent specifications and finer tolerances. Fuel systems, pumps and injectors require cleaner fuel to achieve better combustion and lower emissions. That's why the latest advances in filter media can make the difference between engine power and engine problems.

PRIMARY FILTRATION

Synteq™ Synthetic Media

Donaldson's Synteq fuel filter water separator media uses both cellulose and a melt-blown synthetic layer to achieve the highest levels of fuel filtration performance. This double-layered media increases particulate holding capacity and is a high performance water separator. It has the ability for high efficiency emulsified water separation and can be used in both suction and pressure sides of fuel systems.

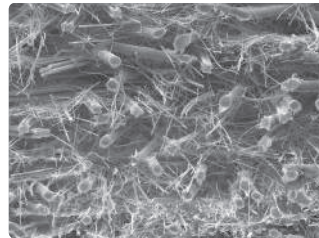

SEM 100x

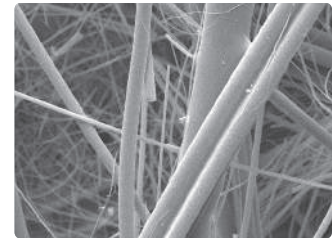

SEM 600x

The polyester layer improves water separation and dirt holding capacity performance. This media is ideal for critical applications or extended service intervals.

Cellulose Media

This fuel filter water separator media is a treated cellulose base material. Treating a cellulose media with a silicone based treatment allows for effective water separation. Typically, this media is used on the suction side of the fuel system to remove harmful water and coarse particulate contaminant.

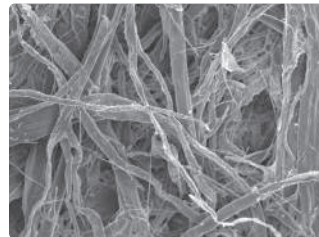

SEM 100x

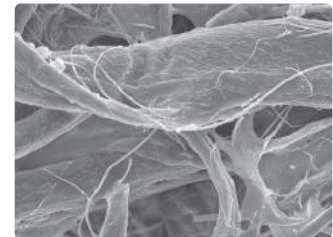

SEM 600x

Water coalesces on the media and drains to the bottom of the can or water collection bowl. Particulate is then trapped and held in media.

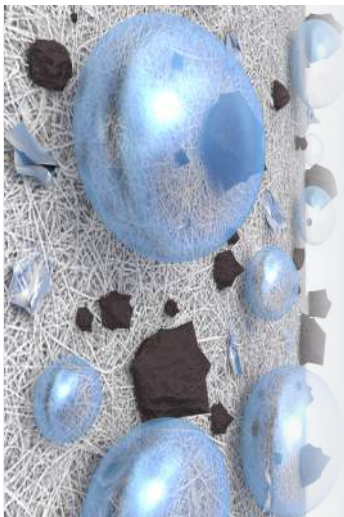

Why remove water in fuel?

Water, both coarse and emulsified, must be removed from the fuel to maximize fuel system performance and service life.

Water in fuel can prematurely wear and oxidize the components within the fuel injectors, leading to:

- Rusting and corrosion of components
- Governor/metering component failure
- Sticky metering components (both pump and nozzle)
- Injection component wear and seizure
- Reduced lubrication



SECONDARY FILTRATION

Synteq XP™ Synthetic Media

Donaldson's high-performance Synteq XP media was developed specifically to overcome the evolving challenges of today's fuels. This ground-breaking filter media takes fuel filtration performance to a whole new level by providing higher efficiency for optimal engine and system component protection.

The Donaldson Blue® line of fuel filters utilizes this advanced media formulation and is your best option for the cleanest fuel for secondary filtration.

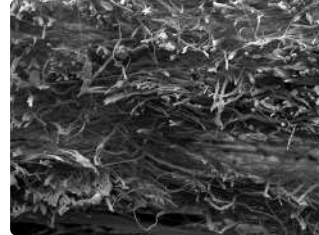

SEM 100x

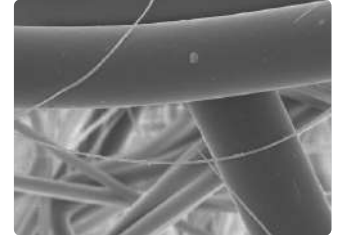

SEM 600x

Cellulose Media

This traditional fuel filter media is most commonly a pleated cellulose base material. This media is tested for compatibility with a variety of diesel fuels, including biodiesel and ULSD.

Larger particulates are trapped on outer layer, while finer particles are captured deeper in the media.

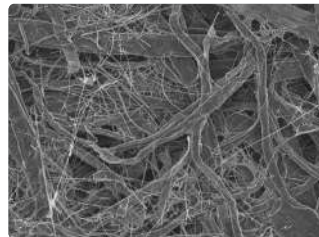

SEM 100x

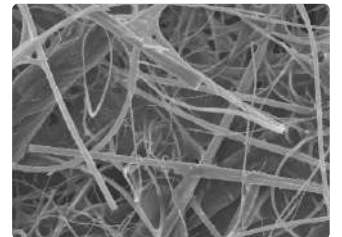

SEM 600x

Fuel Filtration Systems

The following pages present Donaldson’s catalog fuel product offering – with and without water separation. Within each range there are multiple head and filter choices to meet performance and water removal requirements. Donaldson recommends multiple assemblies in parallel for engine applications with higher flow ranges and horsepower (kilowatt). Consult Donaldson for a custom solution.

Fuel Filter Assembly Options

Reference the assembly options below to determine the filtration system that best matches your fuel flow requirements and key design requirements.

Filter Performance Choices

The filter selection charts list the separate filters that fit the same head assembly – these differ by length and filter performance. Choices are presented by primary and secondary filtration, maximum flow rate requirements and level of filtration efficiency.



Fuel Filter Assembly Options		
Families by Filter Diameter	Maximum Flow Range	
	Primary	Secondary
76 mm / 3.00 in	up to 95 lph / 25 gph	up to 150 lph / 40 gph
93 mm / 3.66 in	up to 400 lph / 100 gph	up to 450 lph / 120 gph
108 mm / 4.25 in	up to 600 lph / 160 gph	up to 600 lph / 160 gph
118 mm / 4.65 in	up to 840 lph / 220 gph	up to 1080 lph / 285 gph

How Donaldson Displays Filter Flow versus Pressure Loss Data

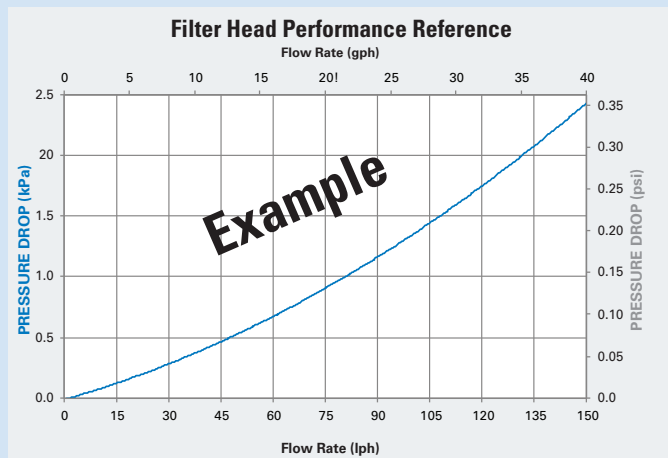

Performance Curve Notes

- Pressure loss was tested per the ISO 3968 standards.
- All flow measurements were made with Ultra Low Sulfur Diesel (ULSD) at 26.6°C / 80°F.
- Test conducted with a sample size of three filters.
- To calculate filter element performance, add an additional 1-2 kPa (0.14 - 0.29 psi) restriction to the filter assembly at max recommended flow rate.



76 mm Filter Assembly

Max Flow Rate

Primary: 95 lph / 25 gph
Secondary: 150 lph / 40 gph
See filter chart for flow rates

Operating Pressure

210 kPa / 0-30 psi with bowl
690 kPa / 0-100 psi without bowl

Temperature Range

-40 °C to 121 °C / -40 °F to 250 °F

Fuel Compatibility

#1 or #2 Diesel, Kerosene, Biodiesel
up to B20 and JP8





Specification Illustrations

BASIC HEAD

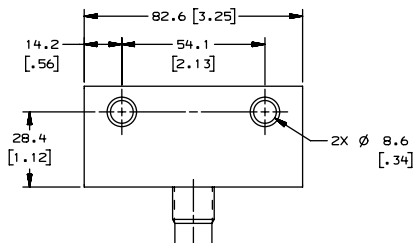
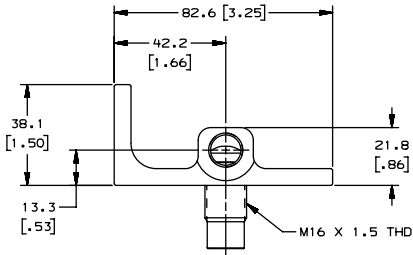
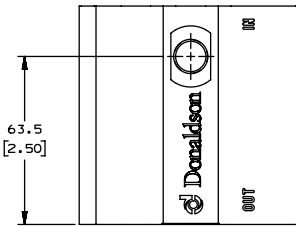
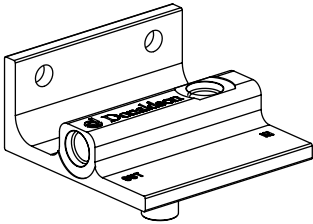

1/2"-20 UNF Ports (2)

PART NO. P562263

BASIC HEAD WITH BLEED VALVE

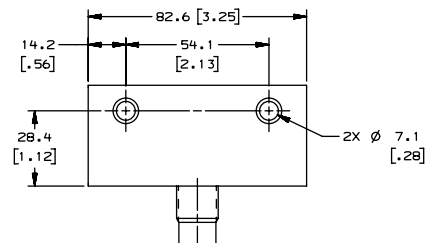
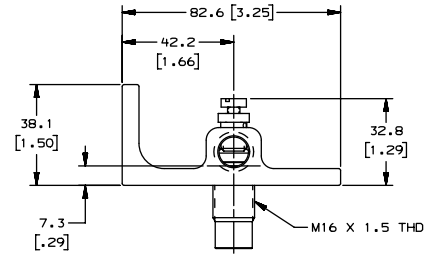
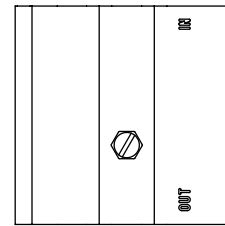
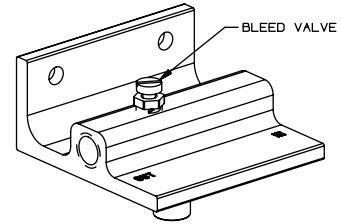

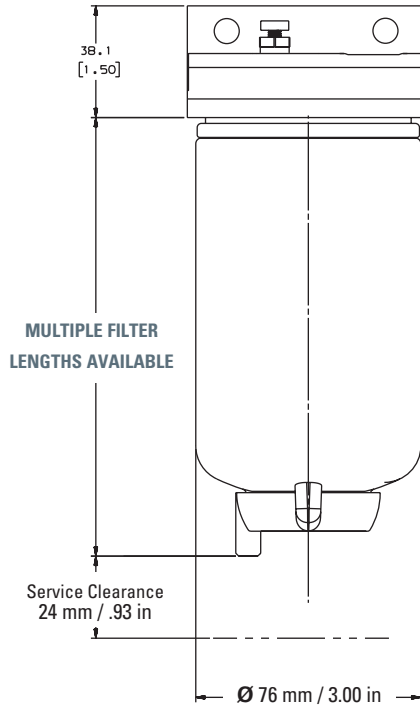

1/4"-18 NPT Ports (2)

PART NO. P560382





Filter Selection Chart

Filter Style	Maximum Recommended Flow Rate		Filter Length*		Media Type	Efficiency @ 99% per ISO 19438	Part Number
	lph	gph	mm	in			
Primary							
 Standard Drain	40	10	101.8	4.01	Cellulose	15 µm	P551039
	95	25	147.7	5.82	Cellulose	3 µm	P551615
					Cellulose	11 µm	P550588
					Cellulose	15 µm	P550248
Secondary							
 No Drain	95	25	82.8	3.26	Cellulose	9 µm	P555095†
					Cellulose	16 µm	P550345†
	150	40	120.0	4.72	Cellulose	9 µm	P550943†
					Cellulose	16 µm	P550440†



* Water Collection Bowl (part no. P569758) adds 50 mm / 1.98 in. to filter length.
† For use on non-high pressure common rail fuel systems only. For Tier 4 applications, contact your Donaldson sales representative.

Performance Curves

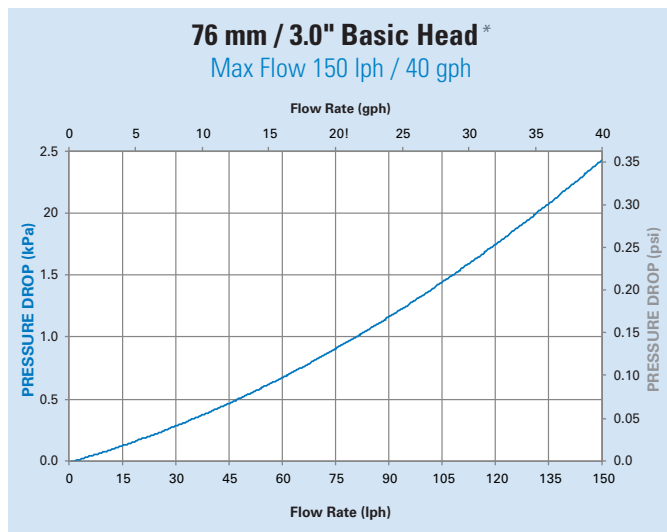

* Filter elements add an additional 1-2 kPa (0.14 - 0.29 psi) restriction to filter assembly at the max recommended flow rate.

Water in Fuel Sensor & Dashboard Display Kit

WIF and Display Kit	Part Number
	X220112*

This kit contains a WIF sensor drain valve with electrical plug, wiring loom and a dash mount LED display.

- Detects separated water in both filter and water collection bowl
- Adjustable LED display brightness
- Automatically resets display after water is drained
- Can be used with any Donaldson Twist&Drain™ style fuel filter

* Lead times may apply. Please contact your Donaldson sales representative for lead time details.



Fuel Filtration

93 mm / 3.66" Filter Diameter



93 mm Spin-on Filter Assembly

Max Flow Rate

Primary: 400 lph / 100 gph
 Secondary: 450 lph / 120 gph
 See filter chart for flow rates

Operating Pressure

210 kPa / 0-30 psi with bowl
 690 kPa / 0-100 psi without bowl

Temperature Range

-40 °C to 121 °C / -40 °F to 250 °F

Fuel Compatibility

#1 or #2 Diesel, Kerosene,
 Biodiesel up to B20 and JP8

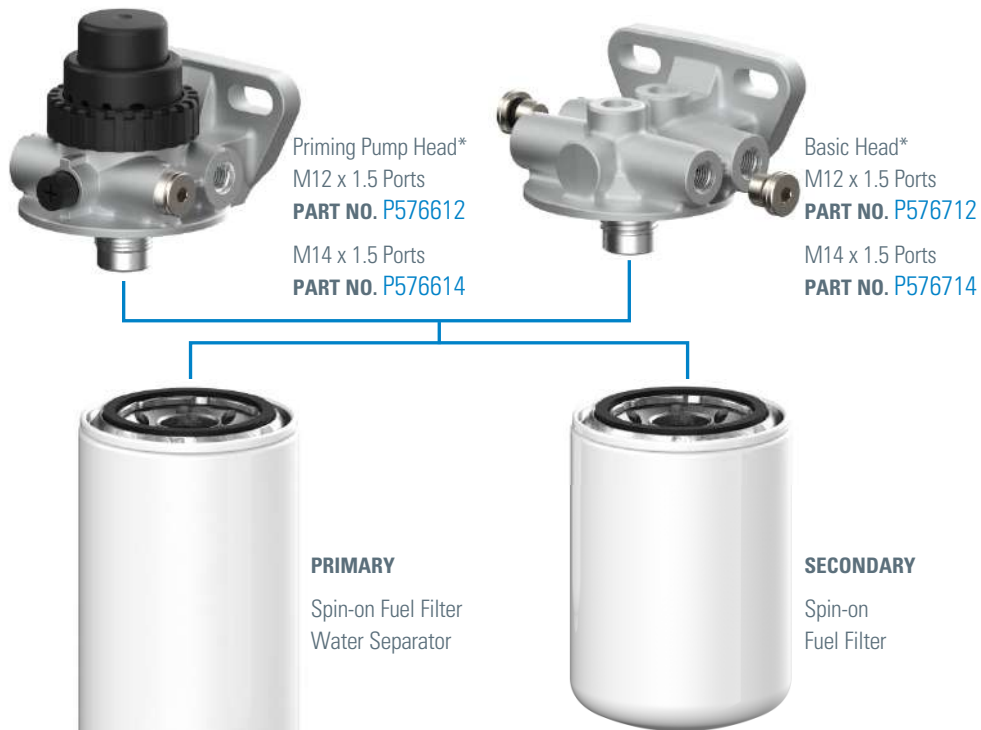

**Optional*
 Filter indicators and switches available



Water in Fuel Sensor & Display Kit
PART NO. X220112
 Lead times may apply



Standard
 Twist&Drain™ Valve
PART NO. P571330

Twist&Drain™ Valve
 1/2"-20 UNF
 Threaded Sensor Port
PART NO. P550865

Twist&Drain™ Valve with
 Passive Water-in-Fuel
 Sensor
 Packard Terminal
PART NO. P570618

Deutsch Terminal
PART NO. P570619

Twist&Drain™ Valve with
 Digital Water-in-Fuel Sensor
 Tyco/AMP Terminal
PART NO. P572227

Deutsch Terminal
PART NO. P570349



Specification Illustrations

PRIMING PUMP HEAD * †

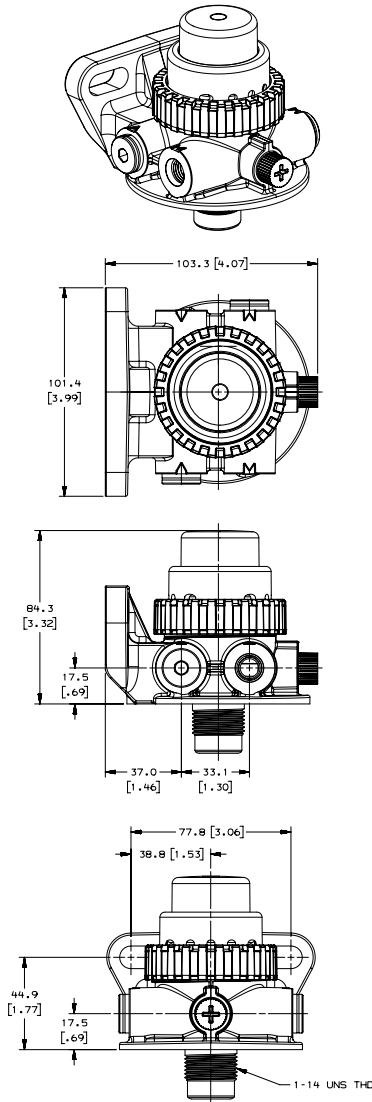

M12 x 1.5 Ports
PART NO. P576612

M14 x 1.5 Ports
PART NO. P576614

BASIC HEAD * †

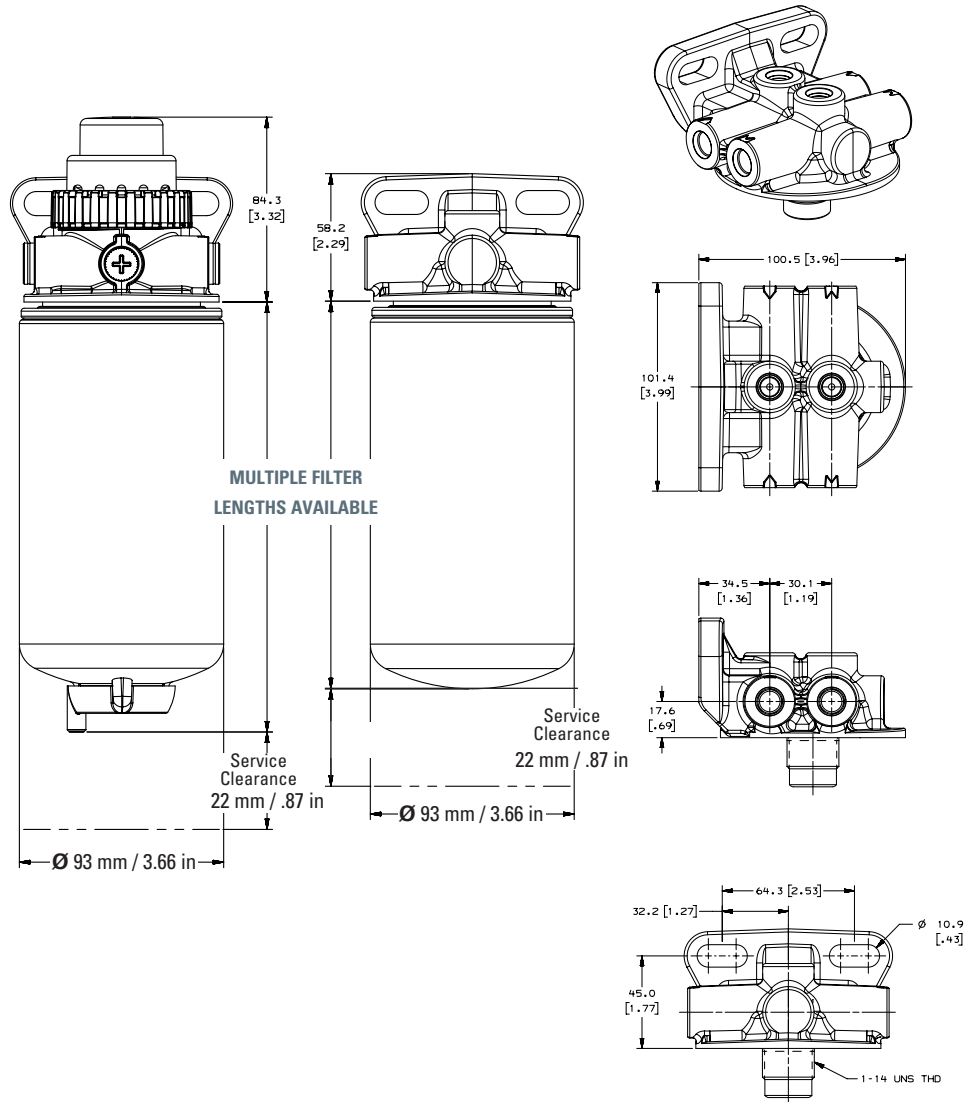

M12 x 1.5 Ports
PART NO. P576712

M14 x 1.5 Ports
PART NO. P576714

NOTES

- * Optional filter indicators and switches available.
 - † Heads include two plugs for use in either the inlet or outlet port positions.
- Contact your Donaldson sales representative for more details.





Fuel Filtration

93 mm / 3.66" Filter Diameter



Filter Selection Chart

Filter Style	Maximum Recommended Flow Rate		Filter Length*		Media Type	Efficiency @ 99% per ISO 19438	Part Number
	lph	gph	mm	in			
Primary							
Standard Drain 	227	60	155.2	6.11	Cellulose	4 µm	P581681†
					Cellulose	10 µm	P581682†
	265	70	194.1	7.64	Cellulose	4 µm	P553203
					Synteq Synthetic	10 µm	P550847
					Cellulose	4 µm	P553207
	340	90	219.3	8.63	Synteq Synthetic	10 µm	P553201
Cellulose					35 µm	P553204	
400	105	252.0	9.92	Synteq Synthetic	10 µm	P551000	
Secondary							
No Drain 	303	80	174	6.85	Cellulose	9 µm	P557440‡
					Cellulose	25 µm	P553854‡
	379	100	200	7.87	Cellulose	9 µm	P555627‡



* Water Collection Bowl (part no. P569758) adds 50 mm / 1.98 in. to filter length.

† Lead times may apply. Please contact your Donaldson sales representative for lead time details.

‡ For use on non-high pressure common rail fuel systems only. For Tier 4 applications, contact your Donaldson sales representative.

Filter Style	Maximum Recommended Flow Rate		Filter Length		Media Type	Efficiency @ 99.9% per ISO 19438	Part Number
	lph	gph	mm	in			
Secondary							
	340	90	174.0	6.85	Cellulose	5 µm	P551313
					Synteq XP Synthetic	4 µm	DBF5814
	450	120	232.8	9.17	Cellulose	5 µm	P551311
					Synteq XP Synthetic	4 µm	DBF5817





Restriction Indicators

Type / Material	Setting	Thread	Part Number
Visual / Mechanical Indicator			
Electric Plated Nickel Steel Thread / Chemical Resistant Nylon	10 inHg	M12x1.5 Male	X220052
	8.5 inHg	M14x1.5 Male	JM56501-00585*
Electrical Switch			
Zinc Nickel Plated Steel Thread	10 inHg	M12x1.5 Male	X220057
		M14x1.5 Male	JM56389-00610*
Wire Harness Adaptor			
Packard for Switches / Flying Leads	N/A	N/A	P633875

For installation on suction side of head assembly in suction applications

* Lead times apply. Please contact your Donaldson sales representative for lead time details.

Performance Curves

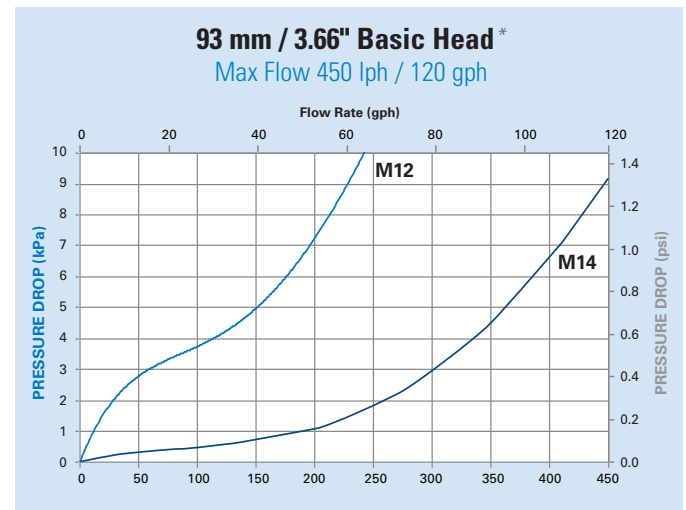
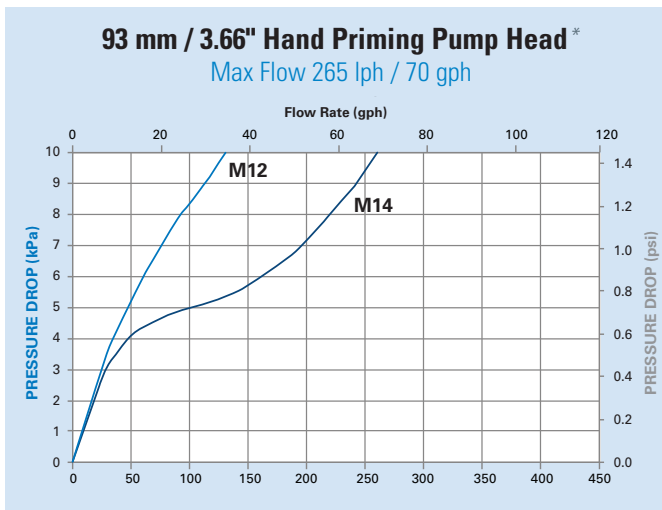

* Filter elements add an additional 1-2 kPa (0.14 - 0.29 psi) restriction to filter assembly at the max recommended flow rate.

Water in Fuel Sensor & Dashboard Display Kit

WIF and Display Kit	Part Number
	X220112*

This kit contains a WIF sensor drain valve with electrical plug, wiring loom and a dash mount LED display.

- Detects separated water in both filter and water collection bowl
- Adjustable LED display brightness
- Automatically resets display after water is drained
- Can be used with any Donaldson Twist&Drain™ style fuel filter

* Lead times may apply. Please contact your Donaldson sales representative for lead time details.



Fuel Filtration

108 mm / 4.25" Filter Diameter



FUEL FILTRATION

108 mm Spin-on Filter Assembly

Max Flow Rate

Primary / Secondary: 600 lph / 160 gph
See filter chart for flow rates

Operating Pressure

210 kPa / 0-30 psi with bowl
690 kPa / 0-100 psi without bowl

Temperature Range

-40 °C to 121 °C / -40 °F to 250 °F

Fuel Compatibility

#1 or #2 Diesel, Kerosene,
Biodiesel up to B20 and JP8



Priming Pump Head*
Chassis Mounting Only

M16 x 1.5 Ports

PART NO. P579972

M18 x 1.5 Ports

PART NO. P579979

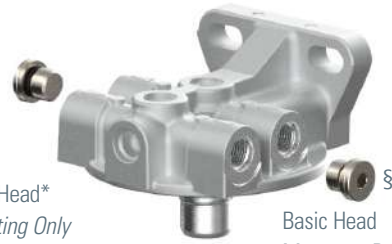

Basic Head

M14 x 1.5 Ports

PART NO. P576071

M16 x 1.5 Ports

PART NO. P576072

† *Optional*
Filter indicators and
switches available



PRIMARY

Spin-on Fuel Filter
Water Separator

SECONDARY

Spin-on
Fuel Filter



Clear Water
Collection Bowl

PART NO. P552860



Water in Fuel Sensor & Display Kit

PART NO. X220112

Lead times may apply

Standard
Twist&Drain™ Valve
‡ **PART NO. P571330**

Twist&Drain™ Valve
1/2"-20 UNF
Threaded Sensor Port
PART NO. P550865

Twist&Drain™ Valve with
Passive Water-in-Fuel
Sensor

Packard Terminal
PART NO. P570618

Deutsch Terminal
PART NO. P570619

Twist&Drain™ Valve with
Digital Water-in-Fuel Sensor

Tyco/AMP Terminal
PART NO. P572227

Deutsch Terminal
PART NO. P570349



Specification Illustrations

PRIMING PUMP HEAD *

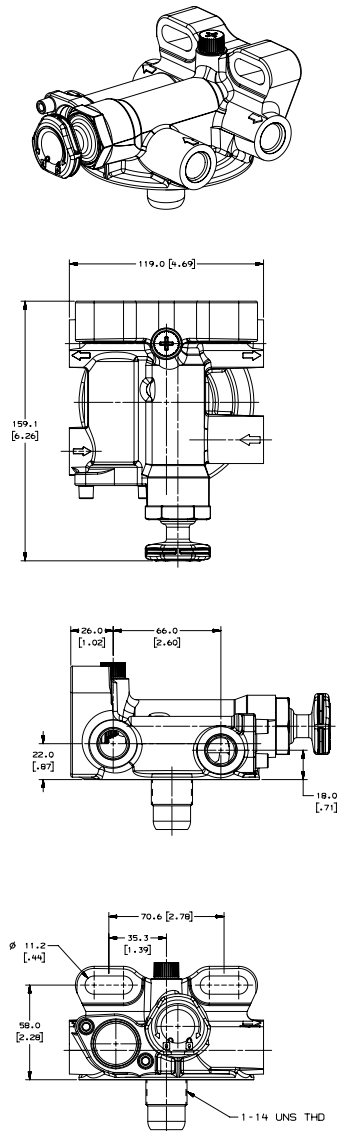

Priming Pump Head
M16 x 1.5 Ports
PART NO. P579972*
M18 x 1.5 Ports
PART NO. P579979*

BASIC HEAD *

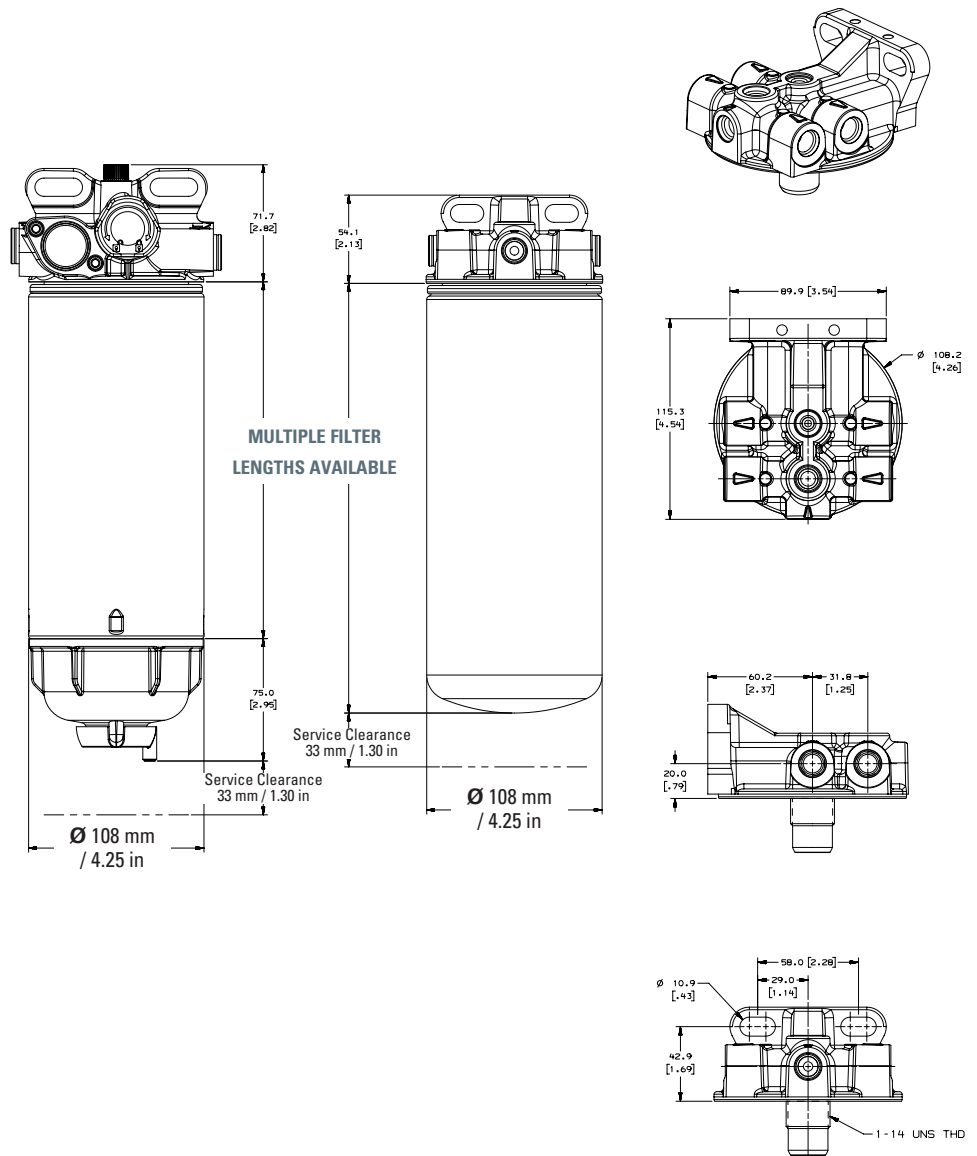

Basic Head
M14 x 1.5 Ports
PART NO. P576071
M16 x 1.5 Ports
PART NO. P576072



NOTES

- * Priming pump head lead times may apply.
 - † Optional filter indicators and switches available.
 - ‡ Long pin WIF sensor available for extended servicing intervals.
 - § Heads include two plugs for use in either the inlet or outlet port positions.
- Contact your Donaldson sales representative for more details.**



Filter Selection Chart



Filter Style	Maximum Recommended Flow Rate		(C) Filter Length*		Media Type	Efficiency @ 99% per ISO 19438	Part Number	
	lph	gph	mm	in.				
Primary								
Standard Drain 	230	60	147.1	5.79	Syn-teq Synthetic	4 µm	P551055	
						10 µm	P551056	
						30 µm	P551057	
	340	90	173.1	6.81		4 µm	P551065	
						10 µm	P551066	
						30 µm	P551067	
	450	120	243.7	9.60		4 µm	P551075	
						10 µm	P551076	
	600	160	243.7	9.60		30 µm	P551077	
						10 µm	P551026	
	Wide Thread Style Filter 	230	60	120.5		4.74	4 µm	P552851
							10 µm	P552852
30 µm					P552853			
340		90	146.5	5.77	4 µm	P552854		
					10 µm	P552855		
					30 µm	P552856		
Service filter only. Requires bowl and drain.		450	120	216.9	8.54	4 µm	P552857	
						10 µm	P552858	
		600	160	216.9	8.54	30 µm	P552859	
						10 µm	P581392	
Filter and Bowl Kit								
Wide Thread Style Filter with Drains † 		230	60	120.5	4.74	Syn-teq Synthetic	4 µm	P559851
	10 µm						P559852	
	30 µm						P559853	
	340	90	146.5	5.77	4 µm		P559854	
					10 µm		P559855	
					30 µm		P559856	
	450	120	216.9	8.54	4 µm		P559857	
					10 µm		P559858	
	600	160	216.9	8.54	30 µm		P559859	
					10 µm		P581387	

* Wide Thread Style Water Collection Bowl (part no. P552860) adds 75 mm / 2.95 in. to filter length.

† Kit includes both a Standard Drain and 1/2"-20 UNF Threaded Sensor Port

Filter Style	Maximum Recommended Flow Rate		(C) Filter Length		Media Type	Efficiency @ 99.9% per ISO 19438	Part Number
	lph	gph	mm	in.			
Secondary							
No Drain 	600	160	262.0	10.31	Syn-teq XP	4 µm	DBF9092





Restriction Indicators

Type / Material	Setting	Thread	Part Number
Visual / Mechanical Indicator			
Electric Plated Nickel Steel Thread / Chemical Resistant Nylon	10 inHg	M14x1.5 Male	JM56501-00585*
Electrical Switch			
Zinc Nickel Plated Steel Thread	10 inHg	M14x1.5 Male	JM56389-00610*
Wire Harness Adaptor			
Packard for Switches / Flying Leads	N/A	N/A	P633875

For installation on suction side of head assembly in suction applications

* Lead times apply. Please contact your Donaldson sales representative for lead time details.

Performance Curves

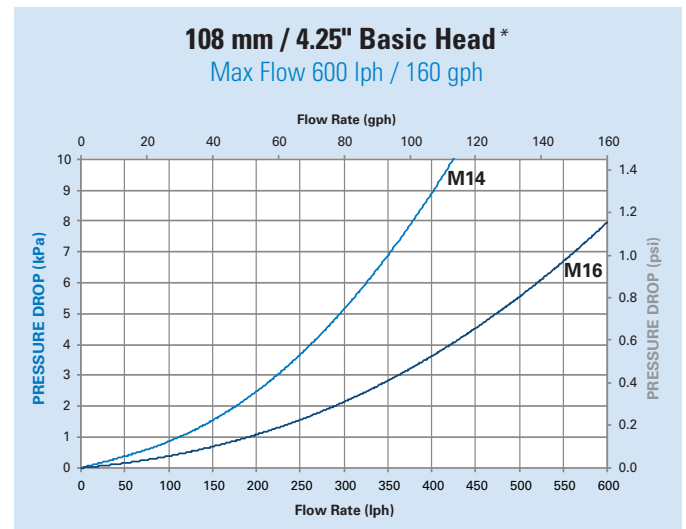
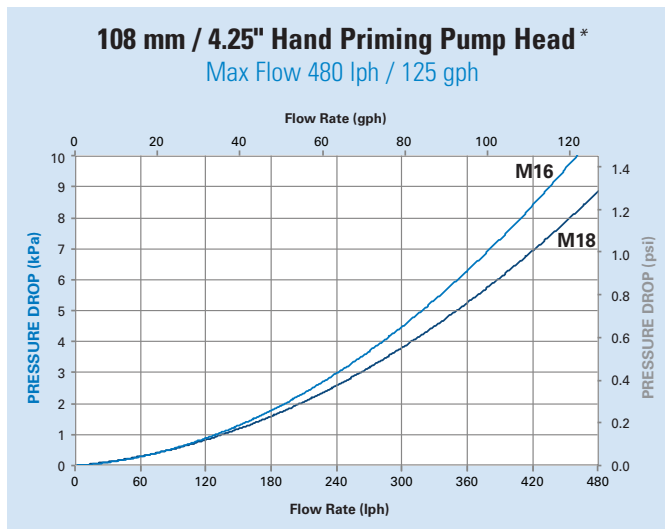

* Filter elements add an additional 1-2 kPa (0.14 - 0.29 psi) restriction to filter assembly at the max recommended flow rate.

Water in Fuel Sensor & Dashboard Display Kit

WIF and Display Kit	Part Number
	X220112*

* Lead times may apply. Please contact your Donaldson sales representative for lead time details.

This kit contains a WIF sensor drain valve with electrical plug, wiring loom and a dash mount LED display.

- Detects separated water in both filter and water collection bowl
- Adjustable LED display brightness
- Automatically resets display after water is drained
- Can be used with any Donaldson Twist&Drain™ style fuel filter



Fuel Filtration

118 mm / 4.65" Filter Diameter



118 mm Spin-on Filter Assembly

Max Flow Rate

Primary: 840 lph / 220 gph
 Secondary: 1080 lph / 285 gph
 See filter chart for flow rates

Operating Pressure

210 kPa / 0-30 psi with bowl
 690 kPa / 0-100 psi without bowl

Temperature Range

-40 °C to 121 °C / -40 °F to 250 °F

Fuel Compatibility

#1 or #2 Diesel, Kerosene,
 Biodiesel up to B20 and JP8



Head*
 M14 x 1.5 Ports
PART NO. P580508



PRIMARY
 Spin-on Fuel Filter
 Water Separator



SECONDARY
 Spin-on
 Fuel Filter



Optional
 Clear Water
 Collection Bowl
PART NO. P569758



Water in Fuel Sensor & Display Kit
PART NO. X220112
 Lead times may apply



Standard
 Twist&Drain™ Valve
PART NO. P571330



Twist&Drain™ Valve
 1/2"-20 UNF
 Threaded Sensor Port
PART NO. P550865



Twist&Drain™ Valve with
 Passive Water-in-Fuel
 Sensor
 Packard Terminal
PART NO. P570618

Deutsch Terminal
PART NO. P570619



Twist&Drain™ Valve with
 Digital Water-in-Fuel Sensor
 Tyco/AMP Terminal
PART NO. P572227
 Deutsch Terminal
PART NO. P570349



Specification Illustrations

BASIC HEAD* †

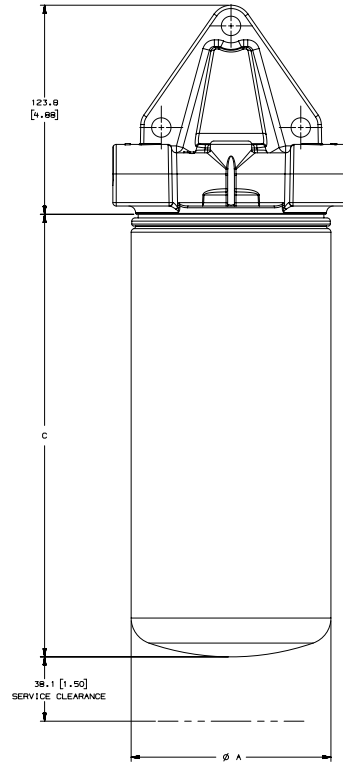
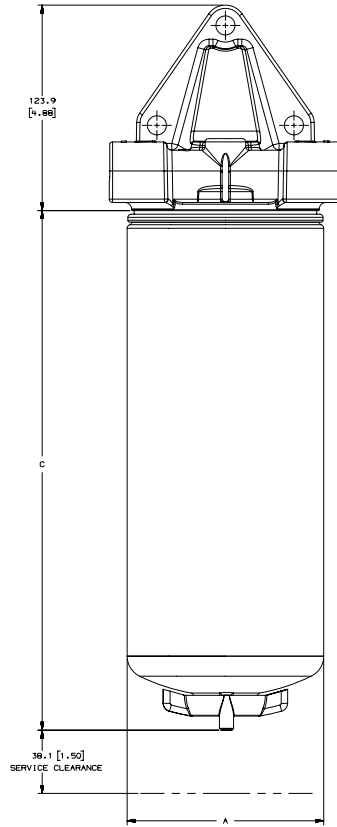
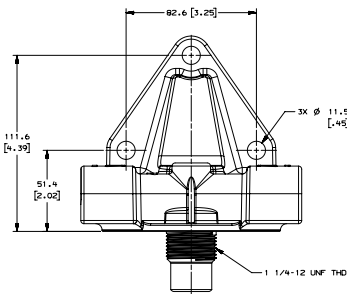
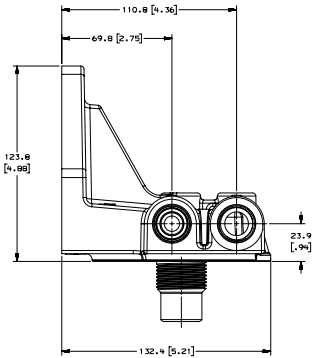
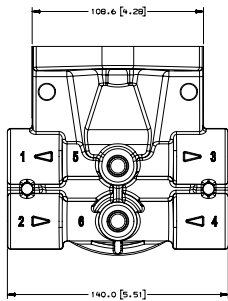
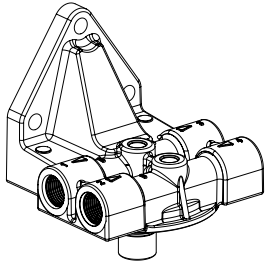

Basic Head
M14 x 1.5 Ports
PART NO. P580508

NOTES



* Head lead times may apply.

† Heads include two plugs for use in either the inlet or outlet port positions.

Contact your Donaldson sales representative for more details.



Filter Selection Chart

Filter Style	Maximum Recommended Flow Rate		Filter Length*		Media Type	Efficiency @ 99% per ISO 19438	Part Number
	lph	gph	mm	in			
Primary							
Standard Drain 	840	220	310.9	12.24	Synteq Synthetic	10 µm	P552006
					Cellulose	17 µm	P552216
Secondary							
No Drain 	1080	285	260.0	10.24	Cellulose	9 µm	P550202†



* Water Collection Bowl (part no. P569758) adds 50 mm / 1.98 in. to filter length.

† For use on non-high pressure common rail fuel systems only. For Tier 4 applications, contact your Donaldson sales representative.

Performance Curves

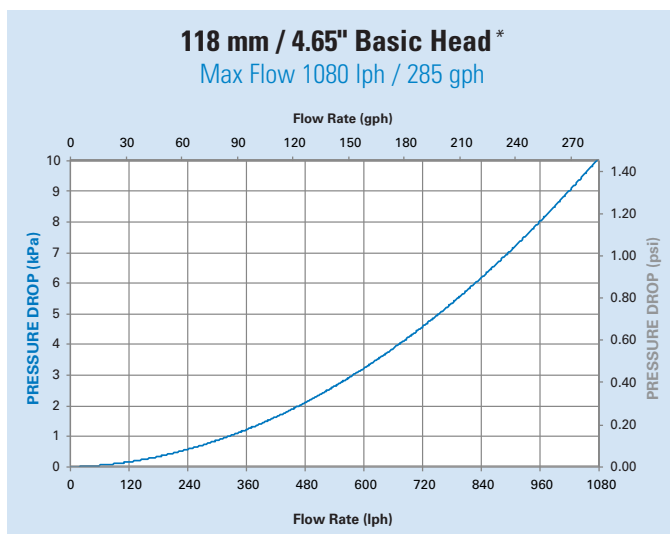

* Filter elements add an additional 1-2 kPa (0.14 - 0.29 psi) restriction to filter assembly at the max recommended flow rate.

Water in Fuel Sensor & Dashboard Display Kit

WIF and Display Kit	Part Number
	X220112*

This kit contains a WIF sensor drain valve with electrical plug, wiring loom and a dash mount LED display.

- Detects separated water in both filter and water collection bowl
- Adjustable LED display brightness
- Automatically resets display after water is drained
- Can be used with any Donaldson Twist&Drain™ style fuel filter

* Lead times may apply. Please contact your Donaldson sales representative for lead time details.



Filter Assemblies

Design Flexibility for a Wide Range of Applications

Overview

Donaldson Blue® Filters	30
Diesel Engine Lube Filtration Overview	31
Filter Media	32
Extended Oil Drain Intervals.....	33

Lube Filtration Systems34



93 mm / 3.66" Filter Diameter.....35

Full-Flow Design
Flow Range up to 91 lpm / 24 gpm



118 mm / 4.65" Filter Diameter.....37

Full-Flow Design
Flow Range up to 170 lpm / 45 gpm



118 mm / 4.65" Filter Diameter.....39

By-Pass Design
Flow Range up to 6.62 lpm / 1.75 gpm @ 85 psi



Extend Maintenance Intervals

REDUCE OIL CONSUMPTION, INCREASE ENGINE PROTECTION



Donaldson Blue® premium lube filters remove more than 90% of contaminants that are 10 microns or larger, compared to 50% or less for typical cellulose filters.

Donaldson
BLUE®



Diesel Engine Lube Filtration Systems

The difference between the various lube filter configurations can be confusing. There are three common filtration approaches.

Full-Flow Filtration

Full flow-filters receive near 100% of the regulated flow in an engine lube system. Full-flow filters provide essential engine protection for maximum cold flow performance and filter life. Most lube filters available today are full flow.

By-pass (Secondary) Filtration

By-pass filtration is when a small portion of the system's oil flow (usually 5-10%) is diverted back to the sump or oil pan before reaching the primary filter. A by-pass filter captures smaller particles than the full-flow filter. Because of the increased efficiency of a by-pass filter, they are more restrictive. To optimize restriction, a by-pass filter should be located in a separate flow path, as illustrated on the right.

Two-stage Filtration

A two-stage filter design attempts to combine the features of both a full-flow and by-pass filter. The two-in-one design significantly increases restriction, causing shorter filter life and decreased cold flow performance. Poor cold flow performance starves the engine of oil during start up, leaving the engine temporarily unprotected. This may lead to increased engine wear that could result in premature repairs or even engine replacement.

TYPICAL DIESEL ENGINE LUBE CIRCUIT

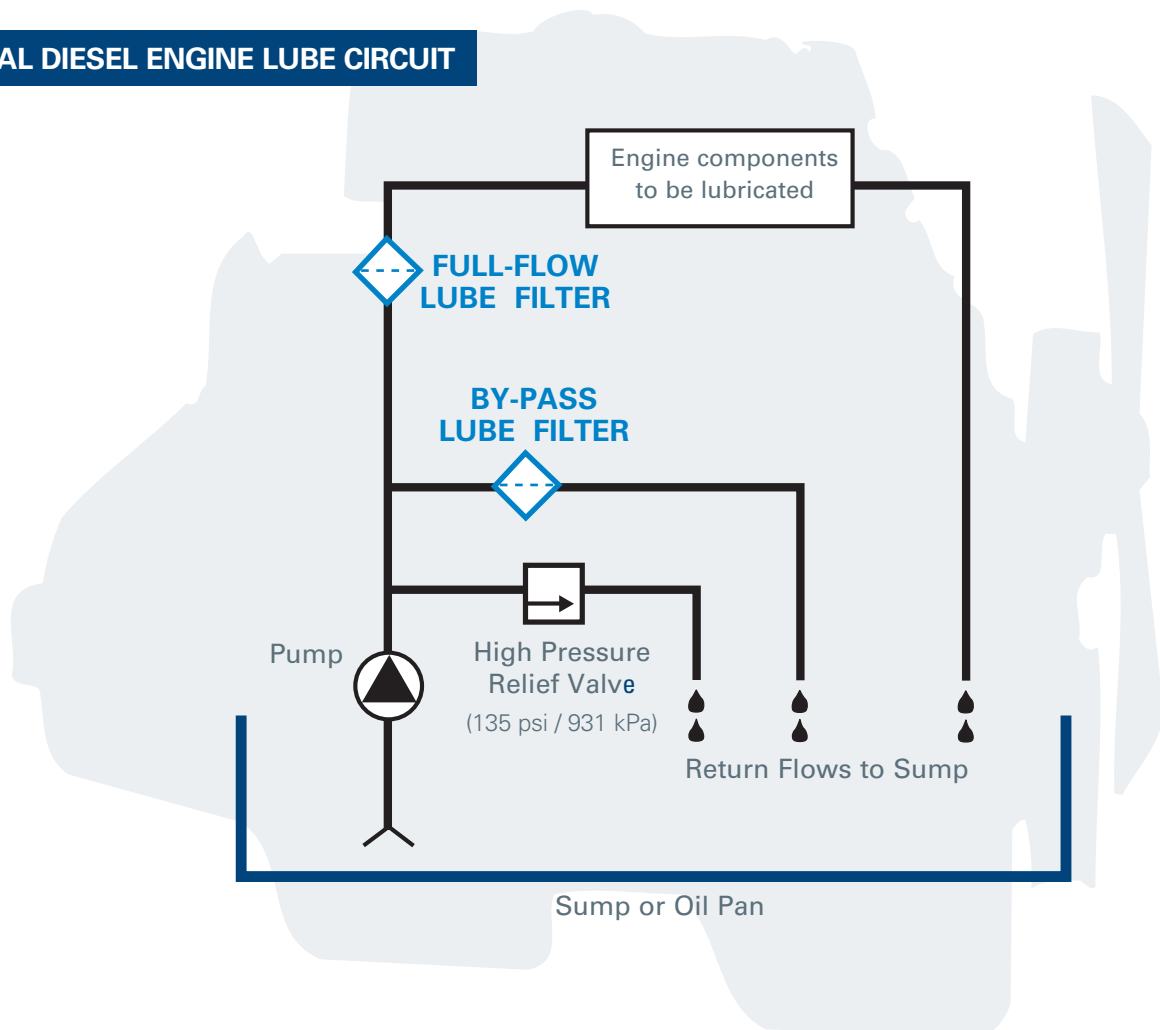

Filter Media

At Donaldson, we have a variety of lube filter medias available to meet the most stringent of engine lube system design requirements. Donaldson engineers have a history of developing media technology that exceeds application cleanliness and service life expectations. In fact, Donaldson was the first company to introduce fully synthetic media to the engine lube market in the early 1980's. This media is now commonly adopted for extended life or enhanced engine protection needs.

New lube media types are constantly under evaluation in our internal laboratories and in controlled field testing. If you have a specific application requirement, please contact Donaldson to see if there are additional media options to better suit your application.

Synteq™ Synthetic Media

Donaldson's fully synthetic lube filter media is constructed of layered, micro-fiberglass synthetic fibers. It provides enhanced durability for extended drain intervals while maintaining or improving efficiency and capacity. Synteq lube media offers lower restriction. Low restriction allows better flow which ensures component protection over a larger range of engine conditions.

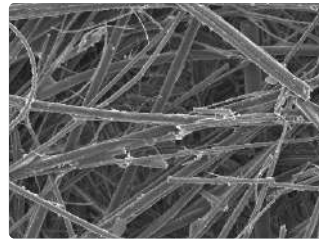

SEM 100x

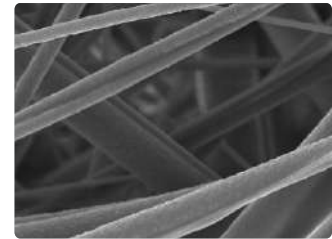

SEM 600x

Synthetic Blend — Cellulose & Synteq™ Synthetic Media

This media is a blend of cellulose and synthetic media technologies. It utilizes the best attributes of both media fiber types to achieve an improved cost to performance ratio for more demanding applications than a cellulose only media can achieve.

This media provides the consistency of layered fibers to capture coarse contaminant coupled with the affordability of cellulose to deliver an efficient and effective performance alternative to traditional cellulose media.

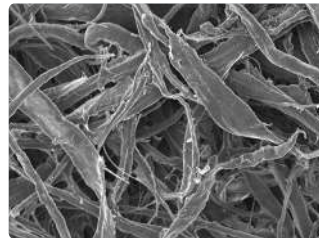

SEM 100x

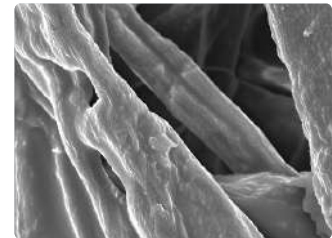

SEM 600x

Cellulose Media

This traditional lube filter media is most commonly a pleated cellulose base material. This media effectively combines an application's efficiency and capacity requirements while maintaining cost effectiveness.

As oil flows through the media, large contaminants are captured on the surface of the filter while smaller contaminant becomes embedded in the underlying media layer.

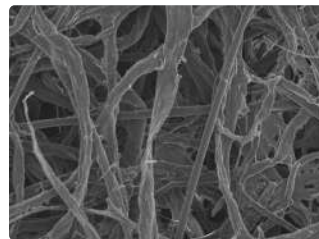

SEM 100x

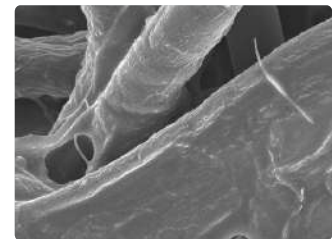

SEM 600x

Extended Oil Drain Intervals

Oil service intervals are pre-determined by engine manufacturers (OEM's) and are designed to provide maximum engine protection under a wide variety of conditions. While a majority of equipment owners follow these guidelines there is a growing trend to extend oil service intervals beyond the OEM recommendations. However, extended oil drain intervals are not for every application. Consider the following:

- Ensure oil meets the American Petroleum Institutes' (API) qualification criteria
- An extended oil drain schedule beyond the OEM's normal service interval should always be conducted in conjunction with a regular oil sampling and testing program
- Equipment operating extremes of heat, cold, idle time, airborne contaminants, and engine load negatively affect oil
- New engine designs today are cleaner burning with reduced emissions and make excellent candidates for extended oil drain intervals
- High-efficiency oil filters will help remove more contaminants, resulting in longer oil life

Donaldson Blue® Lube Filters

Donaldson Blue lube filters are designed specifically for extended maintenance programs. Donaldson Blue filters maintain oil health over the new drain interval and can last as long as the oil. All it takes is a simple cross reference of your current lube filter and you'll reduce oil consumption, increase engine protection and reduce operating costs.

Our Donaldson Blue lube filters use Synteq™ media, which is more effective than standard cellulose filter media at removing small contaminants. It improves lubricant flow and offers increased dirt holding capacity for extended oil drains. Donaldson Synteq™ media technology delivers the optimal balance of efficiency, capacity and restriction for lube systems.

Features

- Removes more than 90% of contaminants that are 10 microns or larger (cellulose filters typically remove 50% or less)
- Double the contaminant carrying capacity of standard cellulose filters – for much longer life
- Delivers lower restriction to provide maximum oil flow and lubrication.
- Heavy-duty, long life seals to support extended service life

Benefits

- Designed specifically to provide longer filter life
- Increase engine protection
- Reduce operating costs

Applications

- On- and off-road applications



Upgrade from Competitive Filters to Donaldson Blue®

Donaldson Blue filters are direct replacements to standard filters – no system modifications or special disposal requirements. Just a simple cross reference of your current lube filter and you'll reduce oil consumption, increase engine protection and reduce operating costs.

Lube Filtration Systems

The following pages present Donaldson’s catalog lube oil product. Product offering includes both by-pass and full-flow filtration designs. Consult Donaldson for a custom solution.

Lube Filter Assembly Options

Reference the assembly options below to determine the filtration system that best matches up with the flow requirements and the key features for design and mounting on your engine.

Filter Performance Choices

The filter selection charts list the separate filters that fit the same head assembly – these differ by length and filter performance. Choices are presented by maximum flow rate requirements and level of filtration efficiency.



Lube Filter Assembly Options		
Families by Filter Diameter	Filter Design	Maximum Flow Range
93 mm / 3.66 in	Full-Flow	91 lpm / 24 gpm
118 mm / 4.65 in	Full-Flow	170 lpm / 45 gpm
	By-Pass (Secondary)	6.62 lpm / 1.75 gpm at 85 psi

How Donaldson Displays Filter Flow versus Pressure Loss Data

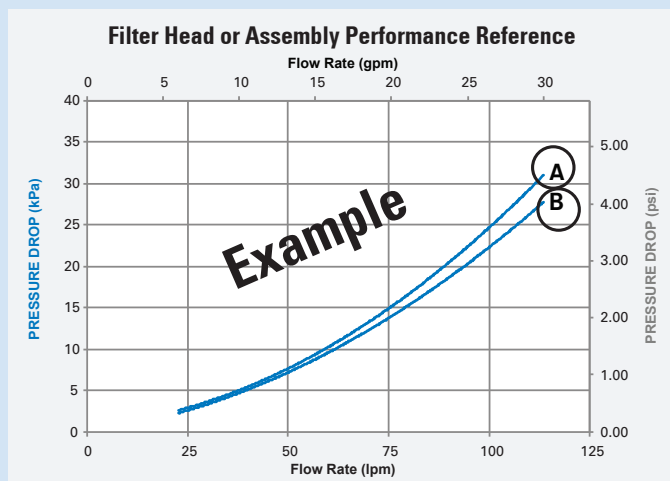

Performance Curve Notes

- Pressure loss was tested per the ISO 3968 standards.
- All flow measurements were made with Mobil DTE Light oil at 144°F / 62.2°C, 15 cSt.
- Test conducted with a sample size of three filters.
- Filter performance curves will list an alpha reference (see circled areas on chart). These labels correspond with the filter choice tables.

93 mm Full-Flow Filter Assembly

Max Flow Rate

91 lpm / 24 gpm

See table for filter flow rates

Operating Pressure

1034 kPa / 150 psi

Oil Compatibility

Compatible with petroleum based fluids (hydrocarbon)

Pressure Relief Valve

Head includes a 1.72 bar / 25 psi relief valve



Head
3/4" -14 NPTF Ports
PART NO. P561134

Specification Illustrations

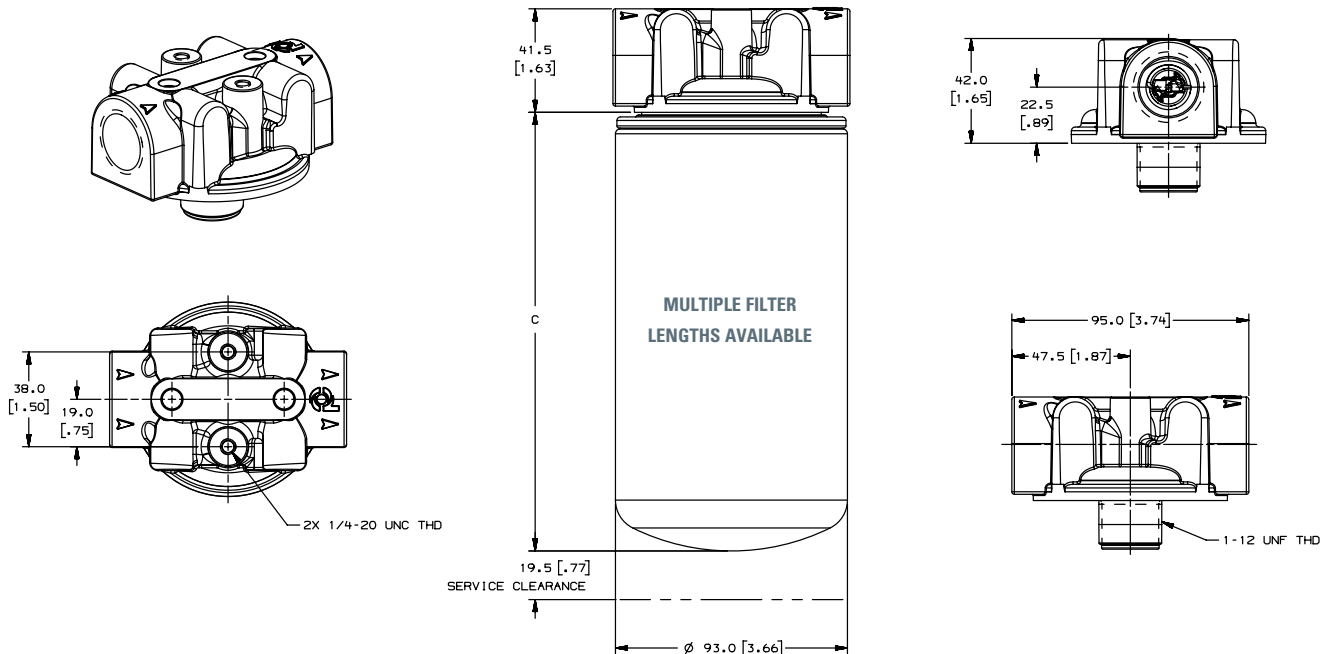



Filter Selection Chart

Maximum Recommended Flow Rate		(C) Filter Length		Media Type	Efficiency @ 99% per ISO 4548-12	Part Number	Performance Curve	Anti-Drain Back Valve	Filter Relief Valve Setting	
lpm	gpm	mm	in						bar	psi
57	15	135.9	5.35	Cellulose	40 µm	P552819	B	Yes	1.30-1.60	18-23
						P555680	C	–	1.30-1.60	18-23
						P559418	B	Yes	2.48	36
76	20	173.9	6.85			P553712	C	–	–	–
						P555616	A	Yes	–	–
						P557207	C	–	0.50-0.70	7-10
						P558250	B	Yes	0.80-1.00	11-17
91	24	209.9	7.87			P553771	A	Yes	2.41	35

Performance Curves

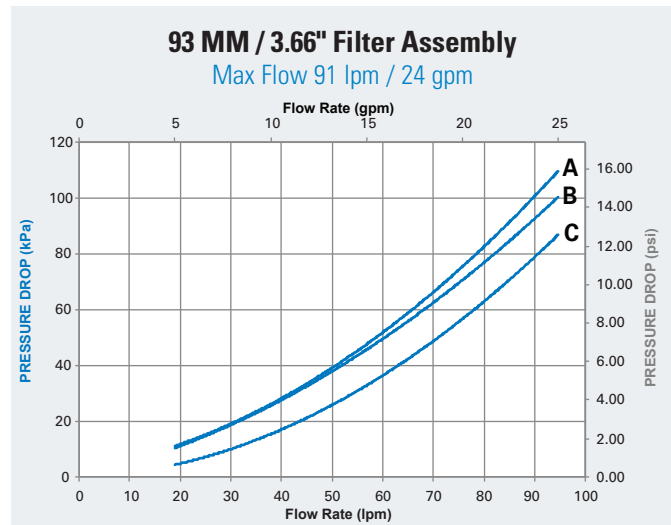
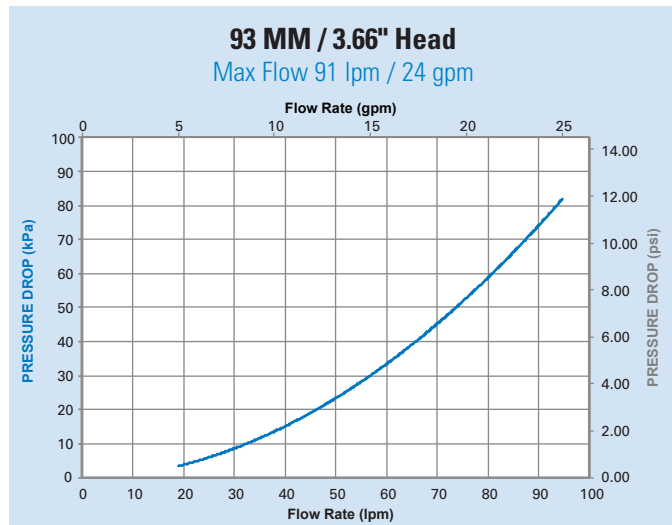

118 mm Full-Flow Filter Assembly

Max Flow Rate

170 lpm / 45 gpm

See table for filter flow rates

Operating Pressure

1034 kPa / 150 psi

Oil Compatibility

Compatible with petroleum based fluids (hydrocarbon)

Pressure Relief Valve

Head includes a 2.76 bar / 40 psi relief valve



Head
1 1/4" - 1 1/2" NPTF Ports
PART NO. P174780

Specification Illustrations

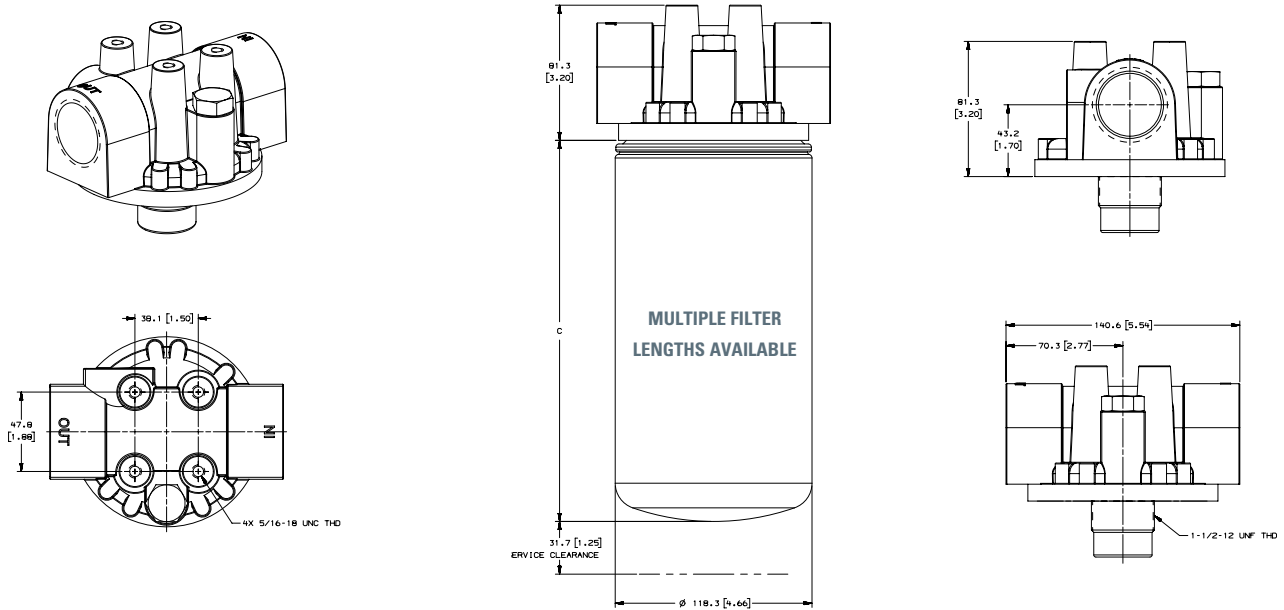



Filter Selection Chart

Maximum Recommended Flow Rate		(C) Filter Length		Media Type	Efficiency @ 99% per ISO 4548-12	Part Number	Performance Curve
lpm	gpm	mm	in				
95	25	157.9	6.22	Synteq Synthetic	16 µm	DBL7947	B
					23 µm	P550947	A
132	35	198.8	7.83	Cellulose	40 µm	P551381	C
		227.0	8.94		23 µm	P550671	D
170	45	260.0	10.24	Synteq Synthetic	16 µm	DBL7670	E
				Cellulose	23 µm	P551670	E

Performance Curves

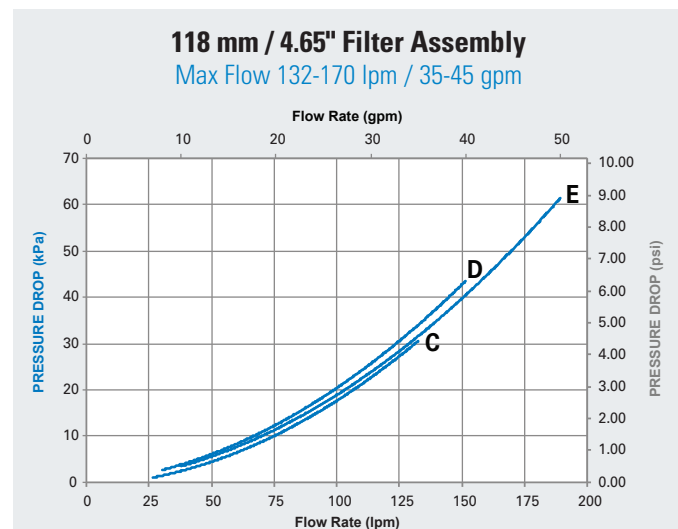
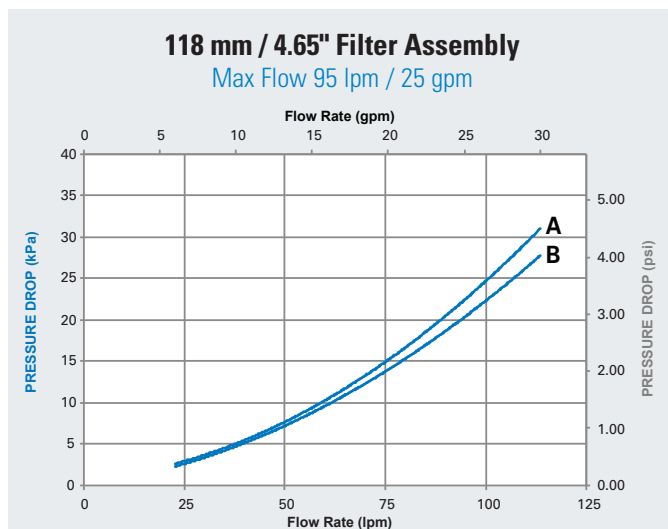
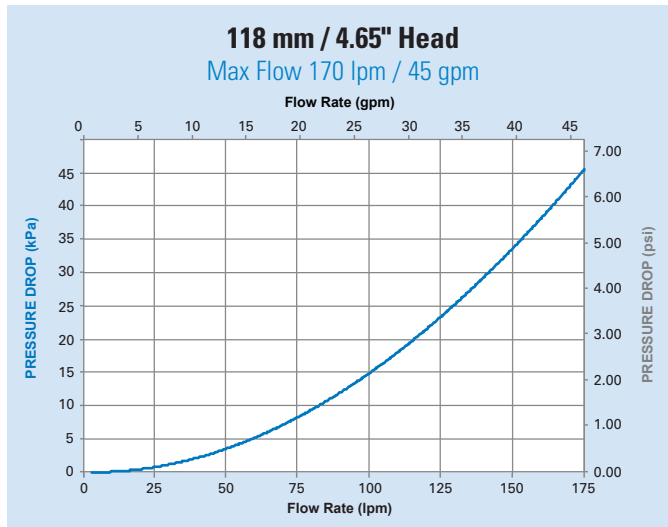

118 mm By-Pass Filter Assembly

Max Flow Rate

6.62 lpm / 1.75 gpm @ 85 psi

Operating Pressure

1034 kPa / 150 psi

Oil Compatibility

Compatible with petroleum based fluids (hydrocarbon)



Head
3/8" -18 NPTF Ports
PART NO. P174777



Specification Illustrations

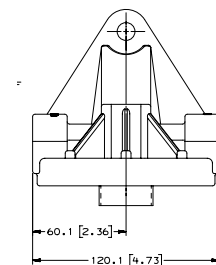
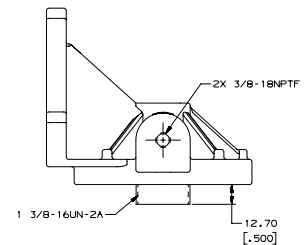
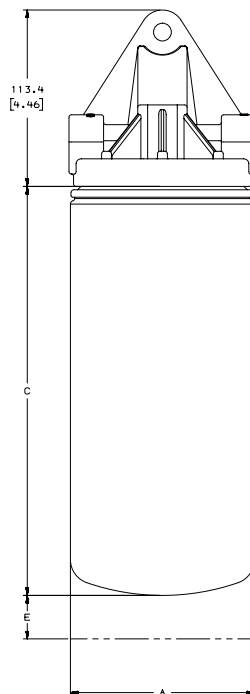
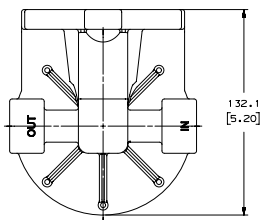
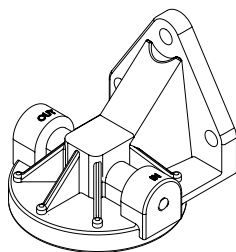



Filter Selection Chart

Maximum Recommended Flow Rate		(C) Filter Length		Media Type	Efficiency @ 99% per ISO 4548-12	Part Number	Performance Curve
lpm	gpm	mm	in				
6.6	1.75	260	10.24	Cellulose	23 µm	P550777	A

Performance Curves

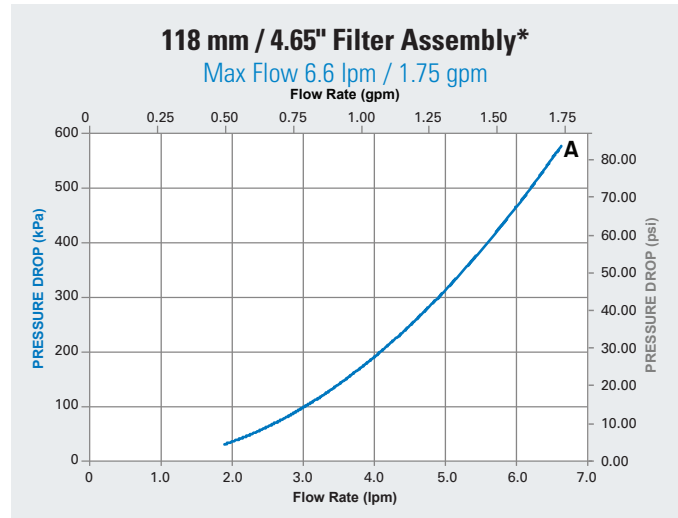
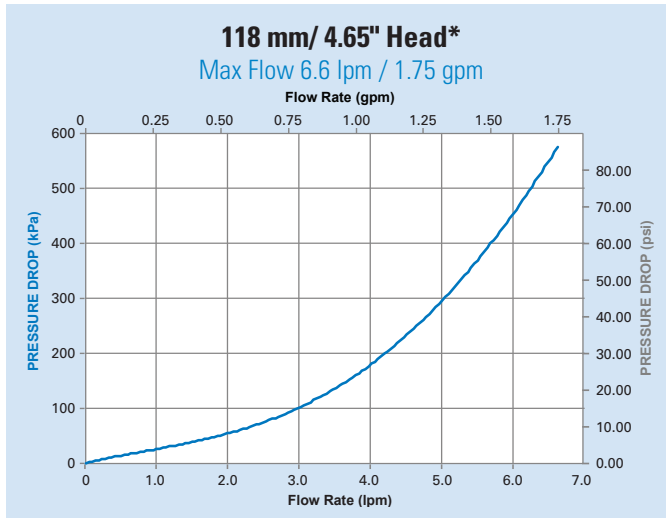

*These performance curves represent clean filter by-pass flow as a function of system pressure.



Filter Assemblies

Remote Mount Coolant Assemblies for Ease of Service

Overview

Donaldson Blue® Filters	42
Diesel Coolant Filtration Overview	43
Filter Media	43

Coolant Filtration Systems

 93 mm / 3.66" Filter Diameter	44
Flow Range up to 1500 lpm / 400 gpm	

SCA/SCA+ Chemical Differences	45
Maintenance Guidelines	46



Extend Coolant Maintenance Intervals

UP TO ONCE A YEAR OR 195,000 KM / 150,000 MI.



Donaldson Blue® premium coolant filters use Synteq™ media to remove fine contaminants from sensitive coolant systems.

Donaldson.
BLUE®



Diesel Engine Coolant Filtration Systems

Coolant system filters are typically partial-flow (by-pass) filters, with less than 10% of the coolant flow circulating through the filter at any given time.

Donaldson's coolant filter offering allows you to choose the method that suits your maintenance practices and schedules.

Donaldson coolant filters are designed to work in a wide variety of operating environments and meet the service requirements of the majority of heavy-duty diesel engines.

Use of the correct filter is important to maintain the proper balance in the system to prevent over concentration (silicate drop out) or under concentration which leads to corrosion, liner pitting or other system problems.

There are multiple types of coolant filters:

- The pre-charge filter which contains enough coolant additive to initially charge the cooling system and to allow for depletion to the first service interval.
- The standard charge spin-on filters which contain adequate chemical additive to maintain cooling systems between service intervals.
- Non-additive filters contain no chemical additives and can be used with cooling systems maintained by liquid additive, systems using long life coolants which require no additive, or on overcharged systems to bring the additive level back to a normal range. Non-additive filters are not intended to be used with water-only systems. Non-additive Donaldson Blue filters will go the distance of your coolant. These filters are intended for extended service coolant users.
- Donaldson Blue filters with additive replenishment technology contain small amounts of time-release additives to replenish coolant and maintain healthy coolant conditions. They are a direct replacement to standard filters.

Filter Media

Coolant filter medias are available to meet the most stringent of engine system design challenges. Donaldson engineers have a history of development and application of media technology that exceeds application cleanliness and service life expectations.

Synteq™ Synthetic Media

Extended life intervals require micro-fiberglass synthetic media. Synteq media provides enhanced durability for extended drain intervals while maintaining or improving efficiency and capacity. This coolant media also offers lower restriction, ensuring component protection over a larger range of engine conditions.

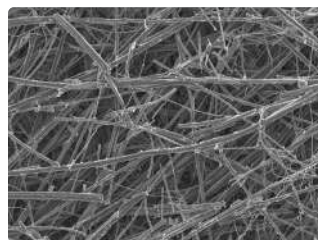

SEM 100x

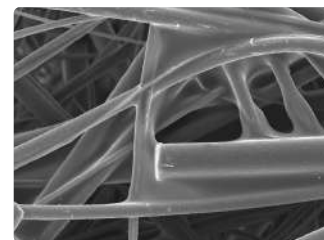

SEM 600x

Cellulose Media

Engine coolant filter media is most commonly a pleated cellulose base material. This media effectively combines an application's efficiency and capacity requirements while maintaining cost effectiveness.

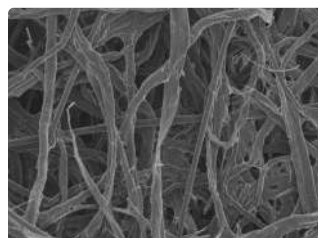

SEM 100x

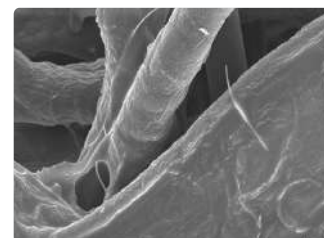

SEM 600x



Coolant Filtration

93 mm / 3.66" Filter Diameter



93 mm Filter Assembly

Coolant System

Up to 1500 lpm / 400 gpm

Operating Pressure

1034 kPa / 150 psi

Oil Compatibility

Compatible with petroleum based fluids (hydrocarbon)



Head
3/8" NPT Ports
PART NO. P550840

Specification Illustrations

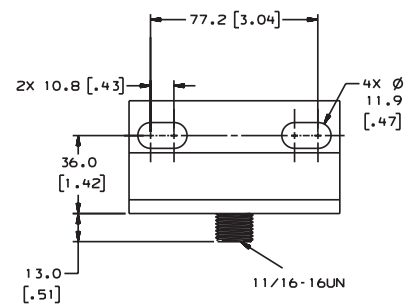
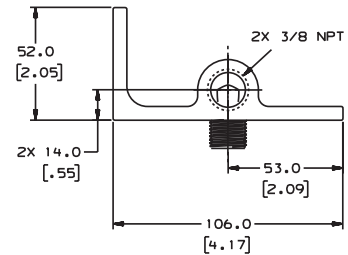
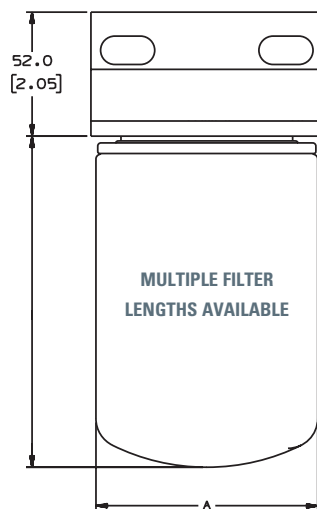
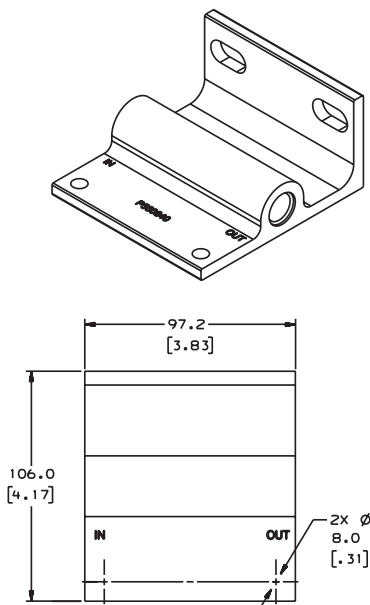



Filter Selection Chart

(C) Filter Length		Media Type	Efficiency @ 99%	Additive Units	SCA Filter Part No.	SCA+ Filter Part No.
in	mm					
4.21	107	Cellulose	50 µm	2 Units	N/A	P552070
				4 Units	P554071	P552071
				6 Units	P554072	P552072
5.35	135	Synteq Synthetic	14 µm	Extended Service, No Additive	DBC4085	
				Extended Service, Additive Replenishment	DBC4088	N/A
		Cellulose	50 µm	8 Units	P554073	P552073
				12 Units	P554074	P552074
				15 Units	P554075	P552075
				Standard Service, No Additive	P554685	
7.87	200	Cellulose	50 µm	23 Units	N/A	P552076

Note

SCA may be substituted for DCA2 and BTE
SCA+ may be substituted for DCA4 and BTA Plus



SCA and SCA+ Chemical Differences

Donaldson SCAs combat a whole series of coolant system problems including, rust, scale from minerals, acidity from antifreeze, the intrusion of air, fuel and oil to coolant, pitting of engine parts from cavitation, foaming from coolant aeration and silicate drop-out from over-concentration.

Function	SCA Chemicals <i>Standard Protection</i>	SCA+ Chemicals <i>Improved Protection</i>
Provides protection against cavitation, erosion, and inhibits corrosion	Nitrite	Nitrite + Molybdate
Alkaline buffer to prevent acidity and control pH	Borate	Phosphate
Reduces corrosion of ferrous metals and aluminum	Silicate	Silicate
Creates a plating effect on copper and copper alloys, protecting them from direct contact with coolant and oxygen and subsequent corrosion	Benzotriazole	Tolyltriazole

Cooling System Service Guidelines

Below are recommended service intervals at flush and re-charge time.

Servicing up to 75.7 L / 20 gal

Install a new filter corresponding SCA/SCA+ units

Service Interval			0-5 gal	6-10 gal	11-15 gal	16-20 gal
@ Miles	@ KM	@ Hours	0-19 L	22.7-37.8L	41.6-46.7 L	60.6-75.7 L
5,000	8045	125 hrs	n/a	2 units	2 units	2 units
10,000	16,090	250 hrs	2 units	2 units	4 units	4 units
15,000	24,135	375 hrs	2 units	4 units	4 units	6 units
20,000	32,180	500 hrs	2 units	4 units	6 units	8 units
25,000	40225	625 hrs	2 units	4 units	8 units	12 units

*SCA or SCA+

Donaldson provides this technical reference as a short course in “Engine Liquid Filtration 101” –for those who want to gain a better understanding of fluid filtration for engines. This guide is offered to aid in choosing the filter that will help you achieve the ideal cleanliness levels and longest life for your critical components.

In engine applications all over the world, we too often see engine systems that don’t include proper fluid filtration, especially fuel. Good filtration needs to be an integral part of the circuit to ensure the long life and proper operation of the pumps, turbos, injectors and bearings. Today diesel engines are very sophisticated with many precision systems working together. These systems require optimum filtration to ensure their performance.

Topics

Engine Components Need Protection	48
How Contamination Damages Precision Parts	48
Where Contamination Comes From	49
Filter Design and Construction	50
Materials and Design Characteristics	51
Filter Media Design and Development	52
Basic Filtration Principles	53
Liquid Filtration Pressure Drop	54
Combining the ISO Rating and Filter Performance Ratings	55
ISO Rating System	55
Filter Efficiency Ratings	56
Frequently Asked Questions.....	57
Fuel	57
Lube	58
Coolant.....	58

Custom System Design Application Worksheets

Fuel Filtration Application Design Worksheet	61
Lube Filtration Application Design Worksheet.....	63

Symbols Used

β	Beta Ratio
cSt	Centistokes
DP	Pressure Drop or Differential Pressure
ISO	International Standards Organization
μm	Micron or micrometer
ppm	Parts per million
SSU SUS	Saybolt Seconds Universal

Material in this section is in the public domain, not confidential, and may be copied for educational purposes at any time. Information was collected from many sources, both public and private, including Donaldson Company, Inc. Engineering Departments, Society of Automotive Engineering (SAE), ISO, and various industry authorities.

Engine Components Need Protection

Engine liquid circuits (lube, fuel and coolant) are designed in all shapes and sizes, both simple and complex in design, and they all need protection from damaging contamination. Abrasive particles enter the system and, if unfiltered; damage sensitive components like pumps, bearings and injectors. It is the job of the filter to remove these particles from the fluid flow to help prevent premature component wear and system failure. As the sophistication of engine systems increases, the need for reliable filtration protection becomes ever more critical.

How Contamination Damages Precision Parts

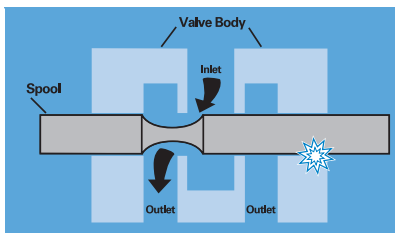

This cutaway view of a simple oil valve illustrates how particles damage components. In normal operation, the spool slides

back and forth in the valve body, diverting oil to one side of the valve or the other. This type of valve is typical in engine oil control circuits. If a particle lodges between the spool and valve body, it will erode small flakes from the metal surfaces. As these flakes are moved back and forth by the action of the spool, they can roll into a burr that jams the spool and disables the valve.

In the pictures below, we see examples of how contamination can impact fuel injectors. Fuel injector nozzles are small passages that deliver an evenly distributed fine mist of fuel to the combustion chamber. These fine passages can become plugged with contamination.



Close up of new (left) and worn (right) fuel injector nozzles.

Another wear area can be the fuel injector needle seat. The needle mates to a seat which is the sealing surface to control the flow of fuel to the combustion chamber. If a particle becomes trapped between the needle and seat it can hold the needle open. In addition, this particle can wear the surface – causing it to become irregular and disable the sealing function of the needle. This can impact the fuel delivery performance of the injector.

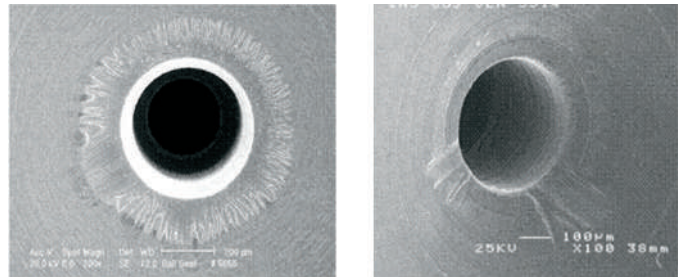

Close-up of worn fuel injector needle seat.

Types of Contaminant

Many different types of contamination may be present in engine fluids, causing various problems. Some are:

- Particulate (dust, dirt, sand, rust, fibers, elastomers, paint chips)
- Wear metals, silicon, and excessive additives (aluminum, chromium copper, iron, lead, tin, silicon, sodium, zinc, barium, phosphorous)
- Water
- Sealant (Teflon®* tape, pastes)
- Sludge, oxidation, and other corrosion products
- Acids and other chemicals
- Biological, microbes

Where Contamination Comes From

New Fluids

Adding new fluid can be a source of contamination. Even though it's fresh from the drum, new engine oil isn't clean. (It may look clean, but, remember, the human eye can only see a particle the size of about 40 µm.) Also, diesel fuel cleanliness varies from pump to pump. Typical fuel cleanliness levels coming out of the pump are ISO rated at 22/21/18. (ISO cleanliness code of 22/21/18 translates to a particle count of 20,000 to 40,000 per milliliter for particles of 4 µm and greater; 10,000 to 20,000 per milliliter for particles of 6 µm and greater; and 1300 to 2500 per milliliter for particles of 14 µm and greater), and water content is typically 200 to 300 ppm. Never assume your fluid is clean until it has been filtered.

Built-In

Built-in contamination, also called primary contamination, is caused during the manufacture, assembly and testing of the engine and its components. Metal filings, small burrs, dirt or sand and other contaminants are routinely found in initial clean up filtration of newly manufactured engines.

Ingressed

Ingressed or external contamination comes from the environment surrounding the engine or vehicle. Dirt can enter the engine liquid supply through crank case breathers or fuel tank breathers and vents and the air intake system. Ingressed moisture, particularly, can cause longer term problems. As a hot system cools at night, cool moisture-laden air can be drawn into the engine or fuel tank; as the air condenses, water is released into the engine or fuel tank. Water in excess of 0.5% by volume in a hydrocarbon-based fluid accelerates the formation of acids, sludge and oxidation that can attack internal components, cause rust, and adversely affect lubrication properties. The severity of ingress and type of contaminant are dictated by the applications and environment.

Induced

Maintenance procedures can introduce contamination into the engine. Opening the engine allows airborne particles to enter. Removing air filters, opening oil caps, fuel tank caps and removal of oil and fuel filters are all possible sources for introducing contamination to an engine. Keep your system closed as much as possible and take care to be sure everything that goes into the engine is as clean as possible. One common example is very often funnels are used fill the engine with oil. The oily funnel will collect dirt between uses. The funnel should be properly cleaned before using it to fill the engine with oil.

In-Operation

The major sources of contamination in the engine are the combustion by-products (soot) and oxidation of the fluids in the engine due to the thermal stressing. Wear-generated contaminants are a hazard during engine operation.

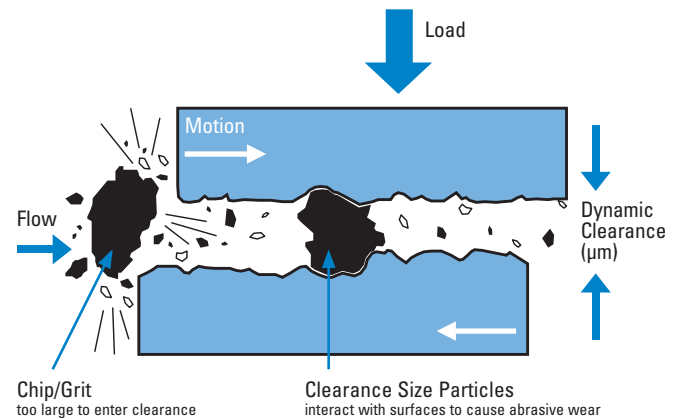

The circuit actually generates additional particles as the fluid comes into contact with the precision machined surfaces of cylinder walls and pistons, injector needles and pistons and crankshaft bearings. Contaminant levels can keep doubling with every new particle generated. The result can be catastrophic if these contaminants are not properly filtered out of the system.

Rubber & Elastomers

Due to temperature, time, and high-velocity fluid streams, rubber compounds and elastomers degrade—thus releasing particulates into the fluid.

Biodiesel

Biodiesel can support biological growth and generate organic contamination and microbes.

Filter Design and Construction

There are two main differences in a filter. The first is the design of the filter itself, and the second is the type of media that is used in the filter.

Filter

Filters have some attributes that are immediately obvious to the casual observer, such as height, inside diameter, outside diameter, media concentration, type of liner, seal design, and the way the media and components are glued or potted together.

Center Tube Liner

Liners must be structurally sturdy to withstand pressure variance, yet open enough to allow good flow. Donaldson's spiral wound construction allows more flow area without compromising the collapse strength. Sharp edges on holes of competitive tubes can cause media to tear during pleat movement.

Donaldson's louver design has hundreds more flow openings than competitors. The louvers are pushed in towards the inner tube, the surface of which media come in contact with is smooth and pleat tip wear is eliminated.

Baffle Plate & Seam

Most heavy-duty liquid filters made by Donaldson have an identifiable baffle plate. They also have open ends that turn up for strength and durability. Competitive products have baffle plates that turn down and in.

Inner Seals

The top seal design must be leak-free, with a gasket or sealing device that ensures a good seal throughout the life of the filter. Standard seals are made of nitrile material, which is fine for most applications. However, if the filtered fluid is diesel or phosphate ester fluid, you'll need a seal made of a fluorocarbon.

Not all competitive filters have a seal between the baffle plate and end cap. Donaldson's seal is constructed of molded elastomer that is designed for extreme cold and heat. Some competitive brands use paper, cork and plastic spacer materials that do not last for the service life of the filter and may not be leak tight.

End Cap Sealing

A leak will occur in a filter when the end plate and filter do not seal completely. Donaldson filter media is embedded deeper in the sealing compound (plastisol, epoxy or urethane).

Media Potting

Media potting is key since it holds the media in place in between the end caps (not visible). Not only should the potting be fully around the ends of the media to prevent leaks, it should also be of a material that can withstand the application. For instance, epoxy potting should be used in filters that must perform in higher temperature environments, phosphate ester fluids and some high water based fluids.

Filter Media

Some of the most important characteristics of filter media (structure, fiber diameter, volume solidity, basis weight, thickness, layering) can only be detected under a microscope.

Curing is the process that adds strength to the filter media and ensures that filter by-pass does not occur. Donaldson cures filter media while it is in a flat, pleated state to ensure consistent and even curing. Uncured media has very low strength and can rupture easily when saturated with oil.

Media Pleating

Inside the filter, the media can vary in thickness, pleat depth and pleat concentration. Donaldson liquid filters are generally equipped with either white synthetic or yellow cellulose material media. It is important to note that media colors vary according to each manufacturer—it should not be assumed that any white-colored media is made of synthetic material.

Inner Spring or Grommet

These components keep the internal filter compressed against the baffle plate and seal. Donaldson spin-on filters use coil springs and grommets which compress and rebound under extreme pressure. Competitive brands use a leaf spring which, when compressed, will bend and deform, allowing unfiltered fluid to by-pass the filter.

Materials and Design Characteristics

Donaldson filters are designed for durability, reliable performance and consistent quality. The same filtration technology and expertise you've come to expect from Donaldson air filters is in every liquid filter we design and manufacture.

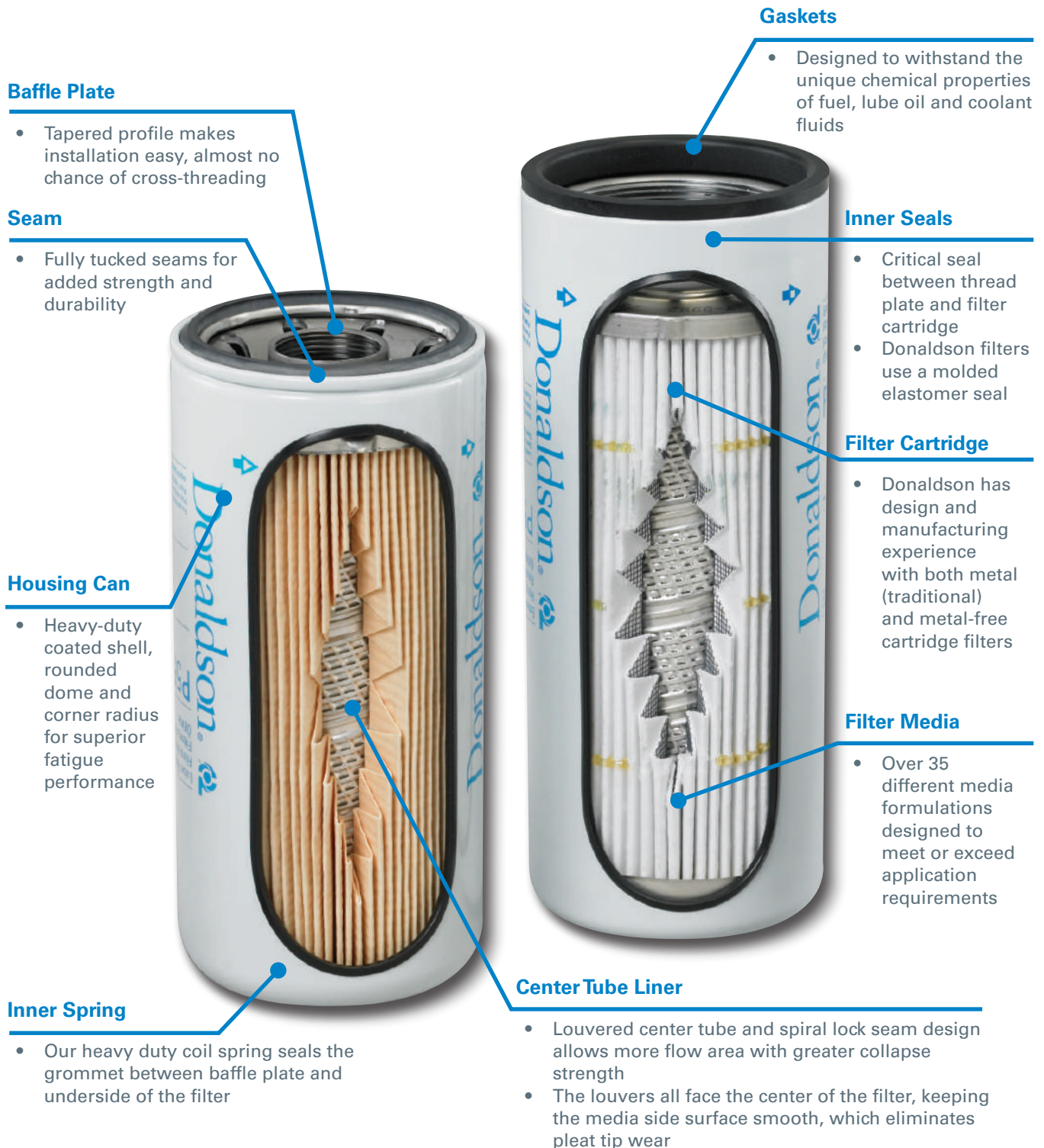

Filter Media Design and Development

Filter Media

Media is a term used to describe any material used to filter particles out of a fluid flow stream. From traditional cellulose to synthetic, the development of proprietary filtration substrates is at the heart of every Donaldson filtration system. If our existing media formulation doesn't meet our customer's specifications, our scientists use our in-house media development laboratory to design new formulations to meet those needs.



Donaldson has many internally developed proprietary computer models which enable us to predict media performance for a given fiber mixture, initial pressure loss for filter elements of various configurations, and filter loading with many different contaminants. This enables us to quickly work through many design concepts to optimize the filtration system for a unique application.

Synthetic media captures more and smaller contaminants than cellulose media. When an application requires higher efficiency filtration than cellulose filter media can deliver, Donaldson uses synthetic media technology.

Look for more information on filtration media available within the fuel, lube and coolant filtration sections.

Media Development

From traditional cellulose to nanofiber – the development of proprietary filtration substrates is at the heart of every Donaldson filtration system. If one of our existing media formulations does not meet our customer's specifications, our scientists use our in-house media development laboratory to develop new formulations that meet or exceed your requirements.

Media Characterization Testing

- Proprietary formulations
- Permeability
- Tensile strength
- Mullen burst
- Basis weight
- Pore size
- Thickness
- Gurley stiffness
- LEFS bench
- 3-Point bend

In-House Media Mill

- For application development
- Trial media production runs
- Development of proprietary formulations

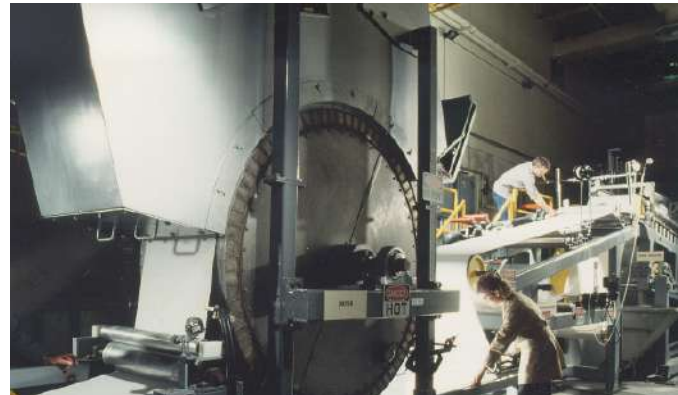

Filtration Performance Testing

- Particle counting
- Multi-pass testing
- Water removal efficiency

Basic Filtration Principles

How Filter Media Functions In a Filtration System

The job of the media is to capture particles and allow the fluid to flow through. For fluid to pass through, the media must have holes or channels to direct the fluid flow and allow it to pass. That's why filter media is a porous mat of fibers that alters the fluid flow stream by causing fluid to twist, turn and accelerate during passage.

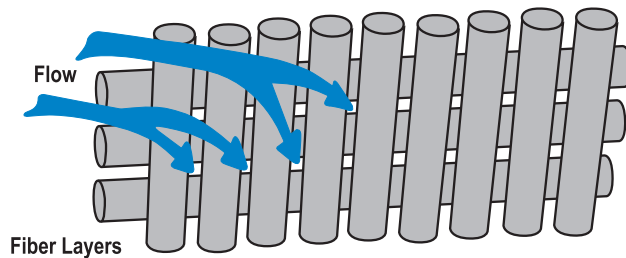

The fluid changes direction as it comes into contact with the media fibers, as illustrated above. As the fluid flows through the media, it changes direction continuously as it works its way through the maze of media fibers. As it works its way through the depths of the layers of fibers, the fluid becomes cleaner and cleaner. Generally, the thicker the media, the greater the dirt-holding capacity it has.

Looking at a cross section view of the fibers, we can see how the flow stream is accelerated as it flows into the spaces between the fibers.

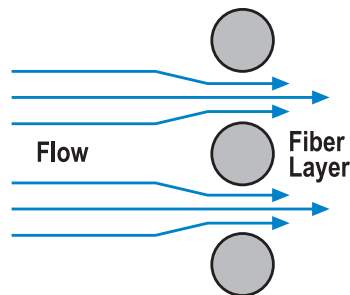

How Filter Media Collects Particles

There are four basic ways media captures particles.

The first, called **inertia**, works on large, heavy particles suspended in the flow stream. These particles are heavier than the fluid surrounding them. As the fluid changes direction to enter the fiber space, the particle continues in a straight line and collides with the media fibers where it is trapped and held.

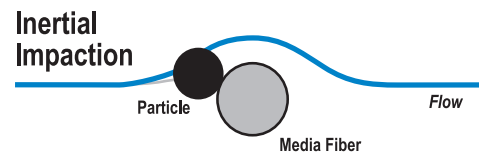

The second way media can capture particles is by **diffusion**. Diffusion works on the smallest particles. Small particles are not held in place by the viscous fluid and diffuse within the flow stream. As the particles traverse the flow stream, they collide with the fiber and are collected.

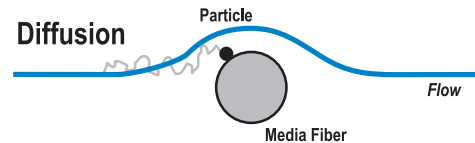

The third method of particle entrapment is called **interception**. Direct interception works on particles in the mid-range size that are not quite large enough to have inertia and not small enough to diffuse within the flow stream. These mid-sized particles follow the flow stream as it bends through the fiber spaces. Particles are intercepted or captured when they touch a fiber.

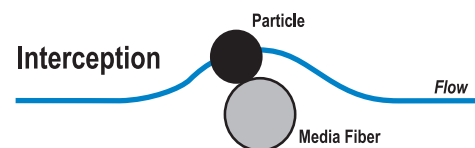

The fourth method of capture is called **sieving** and is the most common mechanism in liquid filtration. As shown below, this is when the particle is too large to fit between the fiber spaces.

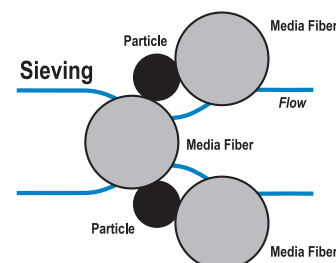

Liquid Filtration Pressure Drop

The difference between the inlet pressure and the outlet pressure is called pressure drop or differential pressure. It's symbolized by ΔP . ΔP is an irrecoverable loss of total pressure caused by the filter, and is mostly due to frictional drag on the fibers in the media. ΔP may increase as the particulate rating or efficiency of the filter gets better. ΔP also increases as the filter is being loaded with contaminant.

Major Factors Contribute to Pressure Drop

1. Filter Media

Media is the main factor influencing pressure drop; indeed, it causes pressure drop. That's why having a low-friction, high-flowing media is so important. The natural cellulose or paper fibers typically used in filtration are large, rough, and as irregular as nature made them.

Donaldson developed a synthetic media with smooth, rounded fibers, consistently shaped so that we can control the fiber size and distribution pattern throughout the media mat, and allow the smoothest, least inhibited fluid flow. Our synthetic media is named Synteq. Synteq fibers offer the least amount of resistance to fluid passing through the media. Consistency of fiber shape allows the maximum amount of contaminant catching surface area and specific pore size control.

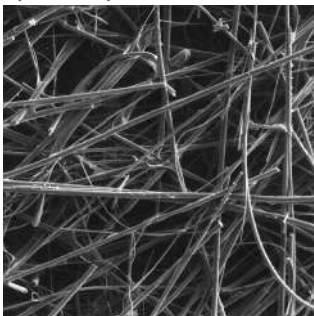

Donaldson Synteq synthetic filter media is comprised of smooth rounded fibers provide low resistance to fluid flow.

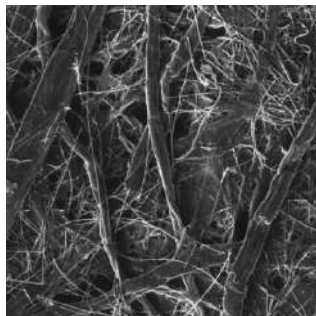

Cellulose filter media photo from scanning electron microscope magnified hundreds of times.

The result is media with predictable filtration efficiencies – removing specified contaminants and maximum dirt holding capacity. Natural cellulose fibers are larger than synthetic fibers and jagged in shape, so controlling size of the pores in the media mat is difficult and there is less open volume. In most applications this results in higher ΔP as compared to synthetic filters. Higher beta ratings

mean there are smaller pores in the media; smaller media pores cause more flow resistance, in turn causing higher pressure drop.

2. Dirt, Contaminant

As dirt gets caught in the media, it eventually begins to build up and fill the pore openings. As the pore openings shrink, the differential pressure, also referred to as pressure drop, increases. This is called restriction.

Typically there is a restriction limit for the system the filter has been applied to. The amount of restriction a filter can have before the system performance becomes affected is called the filter terminal pressure drop. This will usually be the point at which the filter capacity will be stated.

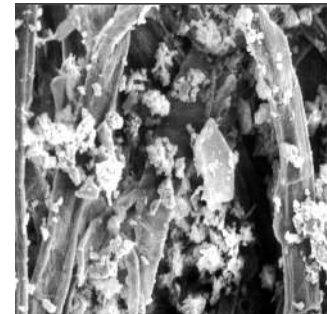

This photo from our scanning electron microscope shows actual dirt particles building up in the media pores.

3. Flow

Higher flows create higher pressure drop. With fast moving fluid, there will be more friction causing higher pressure drop across the media.

4. Fluid Viscosity

Measured in centistokes (cSt) or Saybolt Seconds Universal (SSU or SUS), fluid viscosity is the resistance of a fluid to flow. As fluid viscosity increases, the cSt rating increases. Higher fluid viscosities also mean higher pressure drop because the thicker oil has a tougher time passing through the layer of media fibers. Cold start fluid is a good example of highly viscous fluid.

Filter media, amount of contamination, flow rate, and fluid viscosity are all factors in the importance of sizing the filter for the system requirements. Filters that are too small won't be able to handle the system flow rate and will create excessive pressure drop from the start. The results could be filter operation in the by-pass mode, filter failure, component malfunction, or catastrophic system failures. Filters that are too large for the system can be too costly. Oversized filters require more system fluid and higher cost replacement elements. Finding the optimal filter size is important.

Combining the ISO Rating and Filter Performance Ratings

Many of the components with filters have recommended or specified fluid cleanliness levels to ensure their performance and longevity. This is usually specified per ISO 4406 and with a three number rating expressed in x/y/z format. In this rating each number is a code representing the number of particles greater than a certain size. While filters, on the other hand, have a given efficiency performance based on the media used which is usually expressed in a beta rating or efficiency percentage. A direct connection between the beta rating scale and the ISO rating scale cannot be made.

Many application differences exist in engine liquid filters that need to be understood to begin to correctly apply a filtration media to obtain a desired fluid cleanliness. For example, is it a contained system like the lube oil system where the same fluid is re-circulated and the fluid will be put through the filter multiple times (multi-pass) or is it a fuel system where the fluid is consumed and needs to be cleaned in one time through the filter (single pass). What is the fluid cleanliness that is being started with and what are the application environmental conditions. These are just a few of the things to consider when choosing the correct media to apply.

The ultimate solution is monitoring filter media performance at removing particles in the 4 µm, 6 µm, and 14 µm ranges.

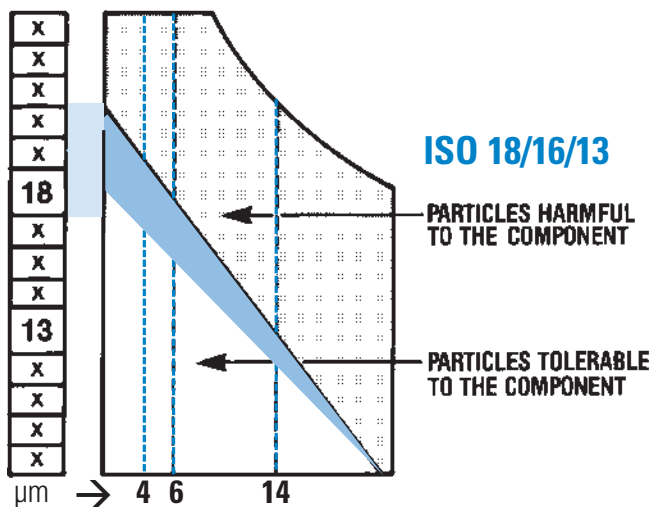

Fluid analysis and field monitoring are the only ways to get these measurements. Combine data from several tests to form a range of performance. Remember, actual filter performance will vary between applications.

ISO Rating System

The international rating system for fluid contamination levels is called the ISO contamination code and it is detailed in the ISO 4406 document. Many component manufacturers publish filtration level recommendations using the ISO code. Manufacturer's ISO contamination levels are based on controlling the particle counts of 4 µm, 6 µm and 14 µm particles in the system fluid. This level is identified by measuring the number of particles 4µm and greater, 6 µm and greater, and 14 µm and greater in one milliliter of the system fluid sample.

ISO 4406 Contamination Codes

Range of number of particles per milliliter

Code	More Than	Up to & Including
24	80,000	160,000
23	40,000	80,000
22	20,000	40,000
21	10,000	20,000
20	5,000	10,000
19	2,500	5,000
18	1,300	2,500
17	640	1,300
16	320	640
15	160	320
14	80	160
13	40	80
12	20	40
11	10	20
10	5	10
9	2.5	5
8	1.3	2.5
7	.64	1.3
6	.32	.64
5	.16	.32
4	.08	.16
3	.04	.08
2	.02	.04
1	.01	.02

Filter Efficiency Ratings

This information is provided as an aid to understanding fluid filter efficiency terminology based on current ISO and SAE test standards. It is not proprietary and may be reproduced or distributed in any manner for educational purposes.

What is Beta Ratio?

Beta ratio (symbolized by β) is a formula used to calculate the filtration efficiency of a particular fluid filter using base data obtained from multi-pass testing.

In a multi-pass test, fluid is continuously injected with a uniform amount of contaminant (i.e., ISO medium test dust), then pumped through the filter unit being tested. Filter efficiency is determined by monitoring oil contamination levels upstream and downstream of the test filter at specific times. An automatic particle counter is used to determine the contamination level. Through this process an upstream to downstream particle count ratio is developed, known as the beta ratio.

Beta Ratio Formula

$$\text{Beta ratio}_{(x)} = \frac{\text{particle count in upstream fluid}}{\text{particle count in downstream fluid}}$$

where (x) is a given particle size

$$\beta(5) = 75$$



Efficiency

The beta ratio is commonly used to calculate the filtration efficiency of a filter and can be converted into an percentage of efficiency at a give particle size.

Efficiency Performance Formula

Efficiency $(x) = \frac{\beta - 1}{\beta}$

(x) is a given particle size

β	Efficiency
2	50 %
5	80 %
10	90 %
20	95 %
75	98.7 %
100	99 %
1000	99.9 %

β 75 is 98.7% for particles 5 μ m and greater

$\beta(5) = 75$ is same as 98.7% @ 5 μ m

What is a micron?

The common unit of measurement in the filtration industry is the micron or micrometer. One micron equals forty millionths of an inch (.00004). In comparison, a human hair is approximately 70 micrometers.

How Big is a Micron?

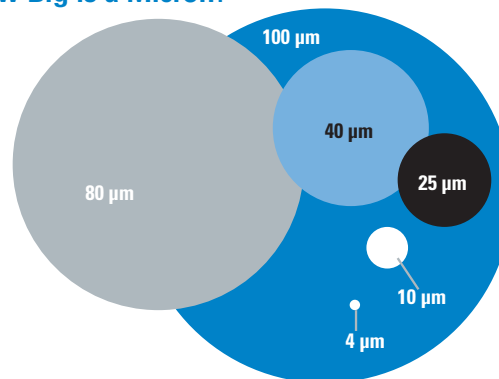

Micron Sizes of Familiar Particles

Grain of table salt	100 μ m
Human hair	80 μ m
Lower limit of visibility	40 μ m
White blood cell	25 μ m
Talcum powder	10 μ m
Red blood cell	8 μ m
Bacteria	2 μ m
Silt	<5 μ m

Frequently Asked Questions

FUEL FILTRATION

What is the meaning of efficiency in relation to a fuel filter?

Efficiency is the ability of the filter to remove particulate (% efficient) at a given micron (size). The type of media being used ultimately defines the filter's efficiency.

What is the capacity of a fuel filter and how is it measured?

Capacity is the measurement (in grams) of the total amount of containment a filter can retain at a rated flow and given end-point (restriction). The type of media (i.e. glass, cellulose, synthetic, etc.) and the amount (square inches) of media defines capacity.

What is restriction?

Restriction is the pressure drop across the filter at a given flow, temperature, and fluid viscosity. The type of media and general filter construction defines restriction.

What is hydrostatic burst pressure?

The hydrostatic burst pressure of a filter is its ability to withstand a deadhead pressure and is typically measured in kilopascal or pounds per square inch. The type of lock-seam, material thickness (bottom and body of filter), shape of tapping plate, and gasket contribute to hydro performance.

How can I estimate my engines total fuel flow rate?

If this information is not available from your engine or equipment manufacturer, use the following formulas for estimating purposes.

Diesel or kerosene fuel systems:

Gallons per Hour is Engine Horsepower (maximum) multiplied by 18% or

$$\text{GPH} = \text{HP} \times 0.18 / \text{LPH} = \text{HP} \times 0.681 / \text{KW} \times 0.914$$

Gasoline fuel systems (carbureted):

Gallons per Hour is Engine Horsepower (maximum) multiplied by 10% or

$$\text{GPH} = \text{HP} \times 0.1 / \text{LPH} = \text{HP} \times 0.379 / \text{KW} \times 0.508$$

Gasoline fuel systems (fuel injected):

Use a straight 40 GPH figure.

$$40 \text{ GPH} / 151 \text{ LPH}$$

How often should I change my fuel filter(s)?

Always follow the equipment or engine manufacturers recommendation on change intervals. The type of equipment and its usage will determine how often the filters need to be changed.

What is the difference between a primary and secondary diesel fuel filter?

The primary fuel filter must offer low restriction because it is mounted on the suction side of the fuel pump where normally a suction pressure of only 34474-41369 pascal / 5-6 pounds per square inch is available. This filter has the job of protecting the transfer pump and lightening the load of the secondary fuel filter (if installed). Primary fuel filters typically have a nominal rating of 10 - 30 microns.

Secondary fuel filters are mounted between the transfer pump and the injectors. The secondary fuel filter is designed to offer full protection to the fuel injectors. Since these filters are mounted after the transfer pump they tend to see much higher pressures than primary filters. Secondary fuel filters typically have a nominal rating of 4 - 10 microns.

What is the purpose a fuel/water separator?

Water flowing at high velocity between highly polished valve seats and through fine nozzle orifices causes a wearing action that approaches that of abrasion. The presence of water, especially with entrained air and various fuel components, causes rust and other chemical corrosion that eats away at the finely mated surfaces. Fuel/water separator filters use chemically treated paper to repel water which then settles by gravity to the bottom of the filter. Accumulated water can be drained from the filter during recommended service intervals if equipped with a drain valve or plug.

What is asphaltene?

All diesel fuels to a degree contain a substance known as asphaltene. Asphaltene is a by-product of fuel as it oxidizes. Asphaltene particles are generally thought to be in the half micron – 2 micron range and are harmless to the injection system, as they are soft and deformable. As these tiny particles pass through the filter media they tend to stick to the individual fibers. If you were to cut open a filter that had choked after a normal service interval you would see a black, tarry substance on the dirty side of the filter; this is asphaltene (oxidized fuel).

Frequently Asked Questions

LUBE FILTRATION

Can the filter cause low oil pressure?

While some pressure drop across the filter is normal, the oil filter is not capable of regulating the lube system pressure. Low oil pressure is generally the result of another malfunction in the engine such as the oil pump losing its prime or the pressure-regulating valve not functioning properly.

What causes a gasket to displace from the oil filter?

Gasket displacement is the result of insufficient gasket compression during installation, excessive lube system pressure or a combination of the two. Any deformation to the filter, from which the gasket was displaced, is a clear indicator that the filter was exposed to excessive lube system pressure. Excessive lube system pressure is most likely the result of a malfunctioning pressure regulating valve that is failing to open properly.

Is it better to use a filter with higher efficiency, regardless of the capacity of the filter?

The correct filter for an application will have a good balance between efficiency and capacity for the application that it is used in. Using a filter with very high efficiency may lower the dirt holding capacity of the filter enough to shorten the life of the filter on the application, increasing the risk of the system going into by-pass.

What is the difference between a by-pass lube filter and a full-flow lube filter?

The oil that goes through the full-flow lube filter goes on to lubricate the engine. The by-pass lube filter receives about 10% of the amount of oil that flows through the full-flow filters and filters that oil at a much higher efficiency. The oil that flows through the by-pass lube filter then returns to the sump. Due to the high efficiency of the by-pass lube filter, it cannot handle the same volume of flow as the full-flow filter. A metering orifice is commonly used to meter the flow of oil through the by-pass filter.

What is the purpose of a by-pass lube filter?

A by-pass lube filter is used to continually filter the oil in a system at a higher efficiency to remove contaminant that is not efficiently removed by the full-flow filter.

Can some filters be substituted for other filters?

This question is presented when customers are trying to consolidate some of the filters that they carry. The filter manufacturers will not approve of such consolidation. While there are some filters that may work in the place of others, filter manufacturers recommend against consolidation, because each filter is designed after a specific OEM filter. Additionally, if changes are made to a specific filter to keep it up to date with the OEM filter that it replaces, it may no longer be an acceptable substitute for another filter that it could be used in place of, previously.

What is the micron rating and efficiency of the filter?

The micron rating of a filter represents the size of particle that the filter can remove from the fluid passing through it. The micron rating should be associated with an efficiency or beta value to indicate how efficient the filter is at removing that size of particle. Any given filter will remove various sizes of particles. The difference between filters is how efficient they are at removing certain sizes of particles.

What type of media does the filter use?

There are many different types of media that can be used in lube filters. Earlier filters used a depth type media, that type of media is still used in some filters today. Most lube filters now use pleated cellulose or cellulose blended media. Some lube filters in specialized applications use synthetic media (glass) or glass-blended media.

What are the advantages of glass media?

Glass media has more uniformity in the size of the opening in the media, which can provide for better flow performance. Glass media also has more dirt holding capacity per square inch of media than most cellulose media blends.

What is the service interval of the filter?

Aftermarket filter manufacturers design their filters to meet or exceed the performance requirements of the original equipment manufacturer, for which the filter is applied. Therefore, the use of an aftermarket filter will not affect the service interval recommendations of the original equipment manufacturer.

COOLANT FILTRATION

Do the liquid and solid additives last the same amount of time?

Yes, when equivalent amounts of supplemental coolant additives (SCA) are added.

How often should system maintenance be performed?

This is dependent on the type of SCA you have chosen to use. Refer to engine and additive manufacturer recommendations.

How can I obtain Safety Data Sheets (SDS) for coolant additives?

SDS information is available from the coolant additive manufacturer or your filter manufacturer.

Are there environmental hazards to not treating a coolant system properly?

There are no “environmental” hazards. There are definitely mechanical hazards related to incorrect coolant system maintenance procedures. (Water pump failures, wet sleeve cavitation erosion and premature catastrophic engine failures.)

Why doesn't a coolant filter come factory installed on some engines?

Due to various engine designs, some engine and equipment manufacturers do not require coolant filtration. Coolant filtration can be added to these systems to prolong water life and/or aid with coolant maintenance.

Is regular tap water all right to use in coolant systems?

Most tap water does not meet engine manufacturer's specifications for use in coolant systems. Please refer to OEM guidelines and consider a coolant analysis program to determine suitability when in question.

I've never had cooling system problems. Why do I need coolant additives and filters?

It is very rare that a gasoline or diesel engine has “never” experienced a failure of a cooling system component, or a related part that couldn't have been prevented with the proper use of SCAs and a coolant filter. Both the short term and the long term economic benefits of properly utilizing SCAs and coolant filtration far out weigh the low initial investment for the appropriate coolant products and their installation.

How often do I need to monitor the system? How do I control monitoring when vehicles are traveling nationwide?

Monitoring, or testing, SCA levels are critical to the over all success of any coolant system maintenance program. SCA level monitoring can be done very easily by using coolant testing. Testing should be done at the maintenance interval for the type of SCA being used to determine if more additives are actually needed to accurately track SCA depletion rates. Testing can also be done at any time between maintenance intervals.

Can liquid SCAs and filters with SCAs be used together?

This depends on the total capacity of the cooling system. Most system capacities are of the size that either the liquid SCA or a filter with solid SCA is utilized. In larger capacity systems, however, both products are used for proper maintenance. Initial installation and maintenance instructions should always be consulted for proper product usage.

What is the difference between filters that are the same physical size and have the same thread size?

The differences in products that look alike are whether or not the filter contains SCA and, if it does, the type and the cooling system volume it will treat.

What is the difference between extended drain and extended service products?

If the SCA has the correct chemical formulation, the time required between total coolant system drain intervals can be extended beyond normal recommended intervals. The maintenance intervals to keep this product working effectively are not extended. Extended service interval products allow the service interval of the SCA to be extended beyond normal.

What is the correct water and antifreeze mixture to be used in coolant systems?

The ideal mixture is 50% water and 50% antifreeze. The coolant mixture should never contain less than 40% antifreeze or more than 60% antifreeze. The water used must meet engine manufacturer's guidelines for use in their coolant systems.

COOLANT FILTRATION, continued

Coolant seems to disappear from my system. Where does it go?

Coolant can seem to “disappear” from the system due to the lack of a coolant recovery system, evaporation, hose and clamp leakage or seepage, water pumps and/or thermostats not functioning properly, improperly sealed, cracked or broken head gaskets, cracked cylinder heads or engine blocks, and leaking or seeping radiators, heater cores or oil coolers. The consistent use of oil analysis can help pinpoint some of these problems and help avoid catastrophic failures.

Why does my coolant foam?

Foam in coolant is usually the sign of trapped air in the system, a leak on the suction side of the water pump, an improperly functioning water pump, low or no coolant in the coolant recovery tank, the lack of a coolant recovery system, the coolant system lack of appropriate SCA's or the combining of incompatible chemicals in the coolant system.

What happens if the coolant system is overcharged with additives?

Over charging or over concentrating a coolant system with additives will result in the formation of solids. These solids will form deposits that drop out and clog passage ways in the system preventing proper heat transfer. These solids are also very abrasive and will permanently damage surfaces they come in contact with. If a coolant filter is in use, it will be quickly plugged up.

What is the best way to determine the freeze point of the coolant?

The most consistently accurate method to determine the freeze point of the coolant is the use of a refractometer. Alternative test methods can also provide an estimate of freeze point.

Can I use a liquid SCA in either a gasoline or diesel engine with no coolant filter?

Yes. However we do recommend the use of an additive free filter on all coolant systems to remove all solid and liquid contamination. Coolant system maintenance should always be done as a complete package to be most effective.

Will adding SCA's to a coolant system postpone or cure existing corrosion problems?

No. If the system is already in poor physical condition, it should be thoroughly cleaned and flushed before the introduction of SCA's. Once it is clean, the SCA's will keep it that way provided proper maintenance intervals are followed.

Is it better to use a filter with coolant additive or a liquid SCA with an additive free filter?

Which coolant maintenance set-up to use is entirely determined by user preference. When properly installed, pre-charged and maintained, both filters with SCA's and liquid SCA's used with additive free filters will offer the coolant system identical levels of protection.

Why can't I use a bigger filter with SCA's?

Coolant filters with SCA's are different physical sizes because they may contain different amounts of additives. The proper amount of SCA to be used to either pre-charge or maintain the additive level in the coolant is determined by the total capacity of the coolant system. Using the incorrect filter can result in an under-charged or an over-charged system. Both of these situations result in improper coolant system performance and could lead to pre-mature failures.

Do supplemental coolant products work with recycled antifreeze?

The vacuum distillation recycling method is the only method accepted by original equipment manufacturers. Some processes return the antifreeze to the customer with SCA's already added. Before installing any products on the systems using recycled antifreeze, you must know whether it contains any SCA's. If it does, an additive free filter is all that is needed until the first service interval is reached. At this point to properly treat the system, you must know what type of SCA was used by the recycler.

Do you really need to test between service intervals?

Yes. Leaks in the system could develop, other components that could allow contamination into the coolant system could fail, foreign substances or incompatible fluids could be introduced to the system or coolant system components such as the thermostat or water pump could fail. All of these situations will directly affect the ability of a properly treated coolant system to perform correctly. Periodic testing with test strips can help avoid the potentially catastrophic results of a system that is not protected.

What does the additive actually do while circulating in the coolant system?

In a clean, properly treated system, the additive physically coats the metal components and protects them from scale build up, corrosion and cavitation erosion (liner pitting).



Donaldson.

ENGINE FUEL FILTRATION SYSTEM APPLICATION DESIGN WORKSHEET

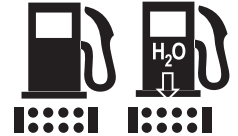

This form is intended to be filled out by an engineer or buyer that interested in a custom fuel filtration design system.

For proper development/design engineering solution, we ask you to provide details about your engine, project due dates, fuel system and performance (mechanical and filtration), system mounting, service, final packaging and product markings.

When completed, please forward this worksheet to your Donaldson representative. Upon receipt, a Donaldson Engineer will assess your requirements and get back to you as soon as possible.

Company Name:		Revision:
Project Name:		
Contact Name:		Title
Phone:	Fax:	Email:

Current Donaldson Model Used: (if applicable)	Your Part Number:
------------------------------------------------------	--------------------------

Engine Information

Manufacturer _____

Model _____

Displacement _____

Number of Cylinders _____

Annual Volume _____

Key Project Dates:

Design Proposal: _____

Prototype Delivery: _____

Design Freeze: _____

PPAP: _____

Start of Production: _____

Fuel System Profile

Primary Filtration Secondary Filtration

Fuel Type:

Standard grade _____

Biodiesel and max. content _____

Alternative: _____

Fuel Delivery System Brand: _____

Fuel Flow Rates: lpm or gpm

Minimum _____ Normal _____ Maximum _____

Fuel System Pressure (kPa):

Minimum _____ Normal _____ Maximum _____

Temperature: °C or °F

Fuel: Min _____ Normal _____ Max _____

Ambient: Min _____ Normal _____ Max _____

Fuel Heating Yes No

Watts _____ Voltage _____

Priming Pump Yes No

Air Relief Valve Yes No

Water Separation _____ %
Volume (ml) _____

Water Collection Bowl No-bowl

Water Sensor Analog Digital

Mechanical Performance

Hydrostatic Pressure Resistance (Burst):

Test Method : _____

Minimum Value: _____ kPA

Mechanical Performance, continued

Collapse Pressure:

Test Method : _____

Minimum Value: _____ kPA

Pressure Testing:

	Min. Cycles	Range (kPa)	Frequency (Hz)
Hydrodynamic		to	
Flow Fatigue		to	
Vibration		to	

Leak Testing:

Test Method : _____

Minimum Value: _____ kPA

Filtration Performance

Test Conditions:

Method: _____

Flow Rate _____ (l/min)

Fluid Viscosity: _____ cSt

Final Restriction: _____ (kPa)

Max. Initial Restriction:

_____ kPa @ _____ cSt

Average Particle Efficiency

> ____ μm	> ____ μm	> ____ μm	> ____ μm

Min. Beta Ratio: $\beta(x) = Y$

X > _____ Y > _____

Minimum Capacity: _____ gms

Validation Tests For Special Fluids:

Mounting & Service

Assembly Mounting:

Side Top Bottom

Other: _____

Filter Change Interval:

_____ km or miles or hours

Do you require installation, service or maintenance recommendations from Donaldson? Yes No

Inventory Managed by Donaldson? Yes No

Packaging

Do you have any special packaging requirements?

Yes No If yes, please check all that apply:

Protective caps: on inlet on outlet on port

Final Assembly:

Bulk / Bagged Bulk / Individual Boxes

Other _____

Product Markings

Do you have any product marking requirements?

Head Assembly? Yes No

Filters? Yes No

If yes, artwork it is assumed customer will provide artwork for filter markings. Donaldson can provide marking area for artwork design. Standard installation icons are available from Donaldson.

Special Requirements or Application Notes

Use this area to provide additional information that will assist Donaldson engineering.

For Donaldson USE ONLY

Date Received: _____

Request From: Catalog Web Site
 Other _____

Assigned to:

Business Unit: _____

Account Manager: _____

Product Manager: _____

Engineer: _____



Donaldson Company, Inc.
Minneapolis, MN

Engine Liquid
Applications Engineering

Doc. No. F115345 ENG (4/21)

© 2021 Donaldson Company, Inc. All rights reserved. Printed in the U.S.A.
Donaldson Company, Inc. reserves the right to change or discontinue any model or specification at any time and without notice.



Donaldson.

ENGINE LUBE FILTRATION SYSTEM APPLICATION DESIGN WORKSHEET



This form is intended to be filled out by an engineer or buyer that interested in a custom fuel filtration design system.

For proper development/design engineering solution, we ask you to provide details about your engine, project due dates, lube system and performance (mechanical and filtration), system mounting, service, final packaging and product markings.

When completed, please forward this worksheet to your Donaldson representative. Upon receipt, a Donaldson Engineer will assess your requirements and get back to you as soon as possible.

Company Name:		Revision:	
Project Name:			
Contact Name:		Title	
Phone:	Fax:	Email:	
Current Donaldson Model Used: (if applicable)		Your Part Number:	

Engine Information

Manufacturer _____
Model _____
Displacement _____
Number of Cylinders _____
Annual Volume _____

Key Project Dates:

Design Proposal: _____
Prototype Delivery: _____
Design Freeze: _____
PPAP: _____
Start of Production: _____

Lube System Profile

Full Flow Filtration Bypass Filtration

Oil Type and Grade

Type: _____ Grade: _____

Oil Flow Rates: lpm or gpm

Min _____ Normal _____ Max _____

Oil System Pressure (kPa):

Minimum _____ Normal _____ Maximum _____

Temperature: °C or °F

Oil: Min _____ Normal _____ Max _____

Ambient: Min _____ Normal _____ Max _____

Oil Change Interval:

_____ km or miles or hours

Pressure Relief Valve: In Engine In Filter

Setting: _____ kPa

Anti-drain Back Valve: Yes No

Setting: _____ kPa Max. leak at valve _____ kPa

By-pass Valve: In Engine In Filter

Setting: _____ kPa

Mechanical Performance

Hydrostatic Pressure Resistance (Burst):

Test Method : _____

Minimum Value: _____ kPa

Collapse Pressure:

Test Method : _____

Minimum Value: _____ kPa

Continued on next page

Mechanical Performance, continued

Pressure Testing:

	Min. Cycles	Range (kPa)	Frequency (Hz)
Hydrodynamic		to	
Flow Fatigue		to	
Vibration		to	

Leak Testing:

Test Method : _____

Minimum Value: _____ kPA

Filtration Performance

Test Conditions:

Method: _____

Flow Rate _____ (l/min)

Fluid Viscosity: _____ cSt

Final Restriction: _____ (kPa)

Max. Initial Restriction:

_____ kPa @ _____ cSt

Average Particle Efficiency (size & %)

> ____ μm	> ____ μm	> ____ μm	> ____ μm
%	%	%	%

Min. Beta Ratio: β(x) = Y

X > _____ Y > _____

Minimum Capacity: _____ gms

Validation Tests For Special Fluids:

Mounting & Service

Assembly Mounting:

Side Top Bottom

Other: _____

Filter Change Interval:

_____ km or miles or hours

Do you require installation, service or maintenance recommendations from Donaldson? Yes No

Inventory Managed by Donaldson? Yes No

Packaging

Do you have any special packaging requirements?

Yes No If yes, please check all that apply:

Protective caps: on inlet on outlet on port

Final Assembly:

Bulk / Bagged Bulk / Individual Boxes

Other _____

Product Markings

Do you have any product marking requirements?

Head Assembly? Yes No

Filters? Yes No

If yes, artwork it is assumed customer will provide artwork for filter markings. Donaldson can provide marking area for artwork design. Standard installation icons are available from Donaldson.

Special Requirements or Application Notes

Use this area to provide additional information that will assist Donaldson engineering.

For Donaldson USE ONLY

Date Received: _____

Request From:

Catalog Web Site

Other _____

Assigned to:

Business Unit: _____

Account Manager: _____

Product Manager: _____

Engineer: _____



Donaldson Company, Inc.
Minneapolis, MN

Engine Liquid
Applications Engineering

Doc. No. F115346 ENG (4/21)

© 2021 Donaldson Company, Inc. All rights reserved. Printed in the U.S.A.
Donaldson Company, Inc. reserves the right to change or discontinue any model or specification at any time and without notice.



**Always
Connected.**
Supporting
maximum uptime.

EASILY MONITOR YOUR WHOLE FLEET WITH A SINGLE DASHBOARD

On-road, off-road and everywhere in between, Donaldson Filter Minder™ Connect can help you maximize productivity and manage downtime no matter the industry, environment, or size of your fleet. Filter Minder Connect monitoring solutions are easy to install and use. Sensors integrate seamlessly into your current filtration systems.



Cloud-based technology is available for air, fuel, hydraulic, and lube oil filtration systems – and for real-time oil condition monitoring.



Data is accessible to users via the MyGeotab Dashboard.



Modular platform can expand to your fleet's requirement as needed.



No new websites, apps, or software are required.



Monitor selected equipment in a single dashboard.



Receive customizable alerts by email or through the dashboard.

Please contact your Donaldson representative for availability within your region.

Global Presence with a Local Touch

At Donaldson, we've built a strong, flexible and responsive network to serve our customers around the world. Support begins and ends with our people.

Reach Across Regions – With 11 regional headquarters, we have engineering, sales and customer service available to help whenever and wherever needed.

Localized Manufacturing – We have nearly 50 manufacturing locations around the world – producing most filters in the regions where they're used.

Distribution Centers – We then move filters and parts to our regional warehouses and distribution center hubs in over 25 countries, meaning the filters you need are never far away.

Logistics – We work with a network of transportation and logistics companies, consolidators and cross-docking facilities to deliver products to distribution partners quickly and efficiently.

Distribution Partners – We've built one of the largest, strongest and most responsive distributor networks in the filter industry. You can find the filters and support you need, nearly anywhere in the world.



Find Info Fast – It's a few clicks away
with shop.donaldson.com



Donaldson Company, Inc.
Minneapolis, MN

donaldson.com
shop.donaldson.com

North America 800-374-1374
Mexico, Latin America, &
Caribbean 52-449-300-2400
Brazil 55-11-4894-6339
Europe 32-16-38-3811
South Africa 27-11-997-6000

Southeast Asia 65-6311-7373
Greater China 86-400-650-0610
Japan 81-42-540-4112
Korea 82-2-517-3333
Australasia 61-02-4350-2033
India 91-124-4807-400

Catalog No. F110024 ENG (4/21)

© 2021 Donaldson Company, Inc. All rights reserved.
Donaldson Company, Inc. reserves the right to change or discontinue any model or specification at any time and without notice. Printed in the U.S.A.